

LEVELS OF KNOTTING OF SPATIAL HANDLEBODIES

R. BENEDETTI, R. FRIGERIO

ABSTRACT. Given a (genus 2) cube-with-holes $M = S^3 \setminus H$, where H is a handlebody, we relate intrinsic properties of M (like its cut number) with extrinsic features depending on the way the handlebody H is knotted in S^3 . Starting from a first level of knotting that requires the non-existence of a planar spine for H , we define several instances of knotting of H in terms of the non-existence of spines with special properties. Some of these instances are implied by an intrinsic counterpart in terms of the non-existence of special cut-systems for M . We study a natural partial order on these instances of knotting, as well as its intrinsic counterpart, and the relations between them. To this aim, we recognize a few effective “obstructions” based on recent quandle-coloring invariants for spatial handlebodies, on the extension to the context of spatial handlebodies of tools coming from the theory of homology boundary links, on the analysis of appropriate coverings of M , and on the very classical use of Alexander elementary ideals of the fundamental group of M . Our treatment of the matter also allows us to revisit a few old-fashioned beautiful themes of 3-dimensional geometric topology.

1. INTRODUCTION

Let M be a compact connected 3-dimensional proper submanifold of S^3 with smooth or PL boundary ∂M . We also assume that no boundary component of M is spherical. Sometimes the interior of M is called a *domain* of S^3 .

The *cut number* of M , henceforth denoted by $\text{cut}(M)$, is the largest number of disjoint connected two-sided properly embedded surfaces whose union does not disconnect M (see [45]). If we denote by χ the Euler characteristic, it is not difficult to show that

$$1 \leq \text{cut}(M) \leq \text{rk } H_1(M) = n - \chi(M),$$

where $\text{rk } H_1(M)$ is the rank of the first homology group of M with integer coefficients, and n is the number of boundary components of M (note that $\chi(M) = \chi(\partial M)/2$). From now on, homology and cohomology are always understood to have integer coefficients.

The *corank* of a group G , henceforth denoted by $\text{crk } G$, is the largest rank of a free group isomorphic to a quotient of G . It is known [45] that the cut number of a manifold coincides with the corank of its fundamental group (see *e.g.* the expository paper [1], where we have also discussed in detail some basic properties of the cut number of domains, including the inequalities mentioned above – we summarize in Subsections 3.6 and 3.7 the results that are relevant to our purposes). We renewed our interest in these classical invariants of manifolds and groups after having pointed out in [1] that the old *Helmholtz’s cuts method*, used to implement the Hodge decomposition of vector fields on spatial domains (see [7]), actually can be applied when the domains have maximal cut number (*i.e.* they have a fundamental group of maximal corank).

When $M = C(L)$, that is the closure of the complement of a tubular neighbourhood of an n -component link L , then by definition L is a *homology boundary link* [43] if $\text{cut}(C(L))$ (or,

2000 *Mathematics Subject Classification.* 57M27 (57M15, 57M05).

Key words and phrases. quandle, maximal free covering, Alexander polynomial, cut number, corank, spatial graph, boundary link, homology boundary link, pattern.

equivalently, $\text{crk } \pi_1(\mathbb{C}(L))$ is maximal, *i.e.* equal to n . In that case, the n disjoint surfaces whose complement is not disconnected are called *generalized Seifert surfaces of L* . Homology boundary links form a distinguished class of links arisen at least since the discovering of Milnor’s link invariants, and which have been widely studied in classical knot theory.

In this paper we are mostly interested to the somehow opposite situation when the boundary is connected and consists of a surface S of genus $g \geq 2$. In this case we have $1 \leq \text{cut}(M) \leq g$.

By Fox’s *reimbedding theorem* [14], up to reimbedding M can be realized as a “cube with holes”

$$M = \mathbb{C}(H),$$

that is the closure of the complement of a genus g handlebody H embedded in S^3 with $\partial H = \partial M$. In such a situation it is natural to look for relations between *intrinsic* properties of M (like its cut number) and *extrinsic* properties depending on the way H is knotted in S^3 .

Although several considerations can be generalized to an arbitrary genus (see Section 9 at the end of the paper), in this paper we concentrate our attention on the case $g = 2$ which already displays a rich phenomenology, as well as some peculiar features. So, from now on, *both H and $S = \partial H = \partial M$ will be assumed of genus 2*.

Fox’s reimbedding Theorem implies that one can study the topology of spatial domains using techniques coming from knot theory. More precisely, a given (genus 2) spatial handlebody H (considered up to isotopy) is the regular neighborhood of infinitely many *handcuff spines* Γ , and every such spine carries a 2–component *constituent link* L_Γ (see Figure 1). The handlebody H is *knotted* if it does not admit any planar spine. Starting from this first level of knotting, we define, in quite a natural way, several *instances of knotting* of H in terms of the *non–existence* of any spine Γ enjoying less and less restrictive properties (which sometimes can be expressed in terms of the constituent link L_Γ). The sets of spatial handlebodies that realize the different instances of knotting are partially ordered by inclusion (in the sense that smaller sets correspond to higher levels of knotting).

Some of the above instances of knotting are implied by intrinsic counterparts, which may be expressed in terms of the non–existence of systems of disjoint properly embedded surfaces satisfying less and less restrictive conditions (see Section 3.8). This also leads to a certain partial ordering relation. Our aim is to clarify as much as possible these extrinsic as well as intrinsic partial orders, and the relations between them. As a key step in our investigation, we recognize a few spatial handlebody invariants that provide effective obstructions to be unknotted with respect to some of our instances of knotting.

2. BASIC RESULTS ON SPATIAL HANDLEBODIES

Consider the planar realizations of the basic θ –, “figure-eight” (f8)– and “handcuff” (hc)–graphs shown in Figure 1.

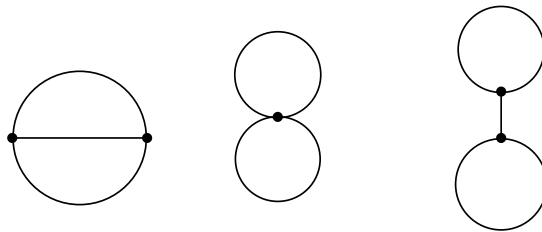

FIGURE 1. From the left to the right: the θ –, (f8)– and (hc)–graphs.

By a (*genus 2*) *spatial graph* we mean a tame embedding Γ of any such graph in S^3 . A (*genus 2*) *spatial handlebody* $H = H(\Gamma)$ is by definition a closed regular neighbourhood of a spatial graph Γ , which is called a *spine* of H . The symbol $C(H)$ denotes the closure of the complementary domain. Sometimes we write also $C(\Gamma)$, if $H = H(\Gamma)$.

Spatial handlebodies are considered up to isotopy. Two spatial graphs are the spines of isotopic spatial handlebodies if and only if they are equivalent according to the equivalence relation generated by ambient isotopy together with the *Whitehead move* shown in Figure 2.

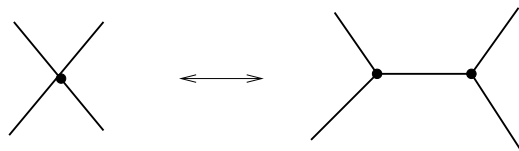

FIGURE 2. Whitehead move.

A spine is *unknotted* if it is isotopic to one of the above planar graph. A handlebody H is *unknotted* if it admits an unknotted spine. Sometimes it is useful to deal with planar diagrams associated to generic projections, that encode the spines, and diagram moves that recover the isotopy of either spatial graphs or handlebodies. The graph isotopy moves are the usual local *Reidemeister moves*, like for link diagrams, and a few additional moves at vertices (see [27]). Some of these *vertex moves* are shown in Figure 3; to get the full set it is enough to change simultaneously the (over/under) crossings in each move of the picture. In order to recover the handlebody isotopy in terms of spine diagrams, it is enough to add the above Whitehead move, interpreted now as acting on diagrams as well (see [23]). We call this whole set of moves *spine moves*.

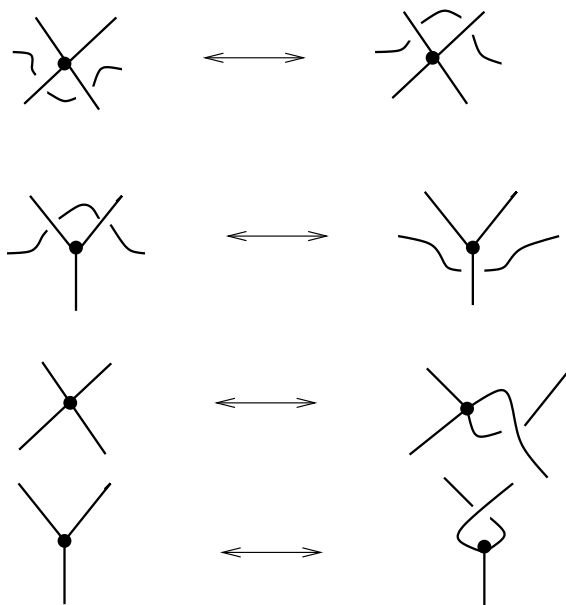

FIGURE 3. Diagram isotopy moves.

2.1. Constituent knots and links. A *constituent knot* of any spatial graph Γ as above is a (spatial) subgraph of Γ homeomorphic to S^1 .

If Γ is a (f8)–graph, then the two constituent knots K_1 and K_2 intersect exactly at the unique singular point (the vertex) p of Γ ; in this case we write $\Gamma = K_1 \vee_p K_2$.

If Γ is a (hc)–graph, then the two constituent knots are disjoint, hence they form a constituent link L_Γ . This is obtained by removing from Γ the interior of its *isthmus*, *i.e.* the edge that connects the two knots.

Let us denote by $\mathcal{K}(\Gamma)$ the knot isotopy classes realized by the constituent knots of Γ . If Γ is either a (f8)– or a (hc)–graph, then $|\mathcal{K}(\Gamma)| \leq 2$; if it is a θ –graph, then $|\mathcal{K}(\Gamma)| \leq 3$.

If $\tilde{\Gamma} \rightarrow \Gamma$ is a Whitehead move producing a (f8)–graph Γ , then $\mathcal{K}(\Gamma) \subset \mathcal{K}(\tilde{\Gamma})$.

The following Lemma is immediate but important.

Lemma 2.1. *The following sets of isotopy classes of spatial graphs and links respectively are isotopy invariants of the handlebody H :*

- the set $\mathcal{S}(H)$ of isotopy classes of (hc)–spines of H ;
- the set $\mathcal{L}(H)$ of isotopy classes of links L_Γ , where Γ varies in $\mathcal{S}(H)$.

Remark 2.2. (1) We will often confuse links and graphs with the respective isotopy classes. The observations before Lemma 2.1 imply that every constituent knot of any (not necessarily handcuff) spine of H arises as a component of some $L_\Gamma \in \mathcal{L}(H)$.

(2) For a single graph Γ , its finite set of constituent knots or links is a rather informative, largely used invariant, to which one can apply all the formidable machinery of classical knot theory. A complication in the case of handlebodies arises from the fact that spines and constituent knots or links are infinitely many. Moreover, there is not an immediate relationship between the knotting of a given spine and the knotting of the associated handlebody. Sometimes this sounds a bit anti–intuitive. For example, essentially by definition every *tunnel number 1* knot (resp. link) arises as a component of some L_Γ (resp. as some L_Γ) of an unknotted (genus 2) handlebody. These knots form a richly structured family of knots (see for instance [8]). It is not difficult to construct tunnel number 1 links with knotted components (see *e.g.* Figure 4, where we describe an example taken from [31]).

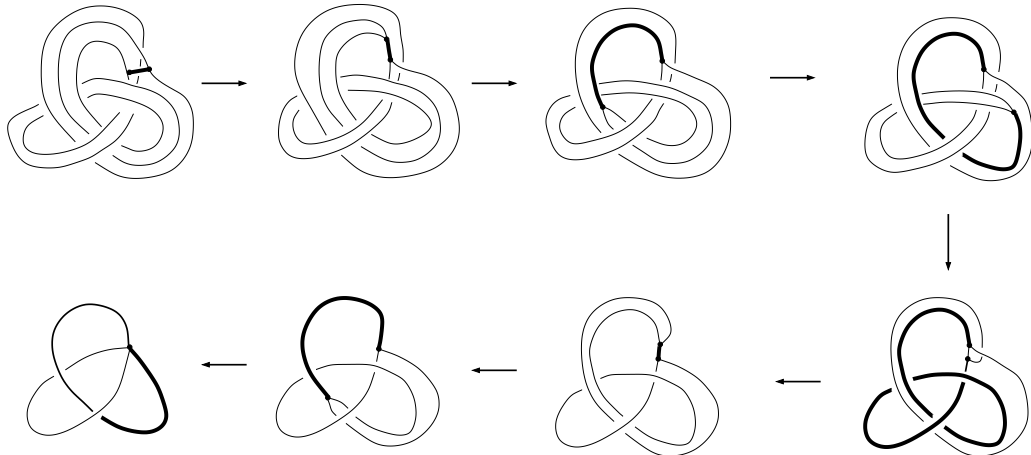

FIGURE 4. The diagram on the left of the top row shows an (hc)–graph Γ whose constituent knots are both knotted. The sequence of moves shows that Γ is a spine of the unknotted handlebody.

In the same spirit, by varying the integers k and h in Figure 5 (the meaning of the boxes is defined in Figure 6), we get infinitely many non-isotopic (hc)-spines Γ of an unknotted handlebody, with arbitrary linking number of the components of L_Γ . See also Remark 4.2 below.

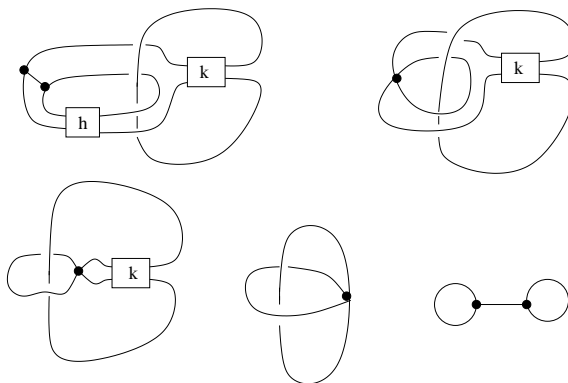

FIGURE 5. Spines of the unknotted handlebody.

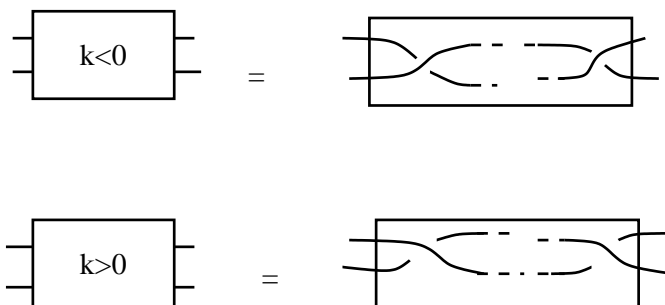

FIGURE 6. The boxes used in Figure 5.

3. INSTANCES OF KNOTTING, INTRINSIC AND EXTRINSIC KNOTTING:
STATEMENT OF THE PROBLEMS AND MAIN RESULTS

We are going to use the invariants of H introduced in Lemma 2.1 above, in order to define certain *instances of knotting* of H . We will distinguish the instances defined in terms of the set $\mathcal{S}(H)$ of the handcuff spines of H , from the ones defined only in terms of the set $\mathcal{L}(H)$ of the constituent links. From now on, unless otherwise stated every spine is understood to be of handcuff type.

3.1. Spine-defined instances of knotting. Let us recall that a 2-component link $L = K_1 \cup K_2$ is a *boundary link* if K_1, K_2 admit *disjoint* Seifert surfaces S_1, S_2 . It is readily seen that such surfaces, if they exist, do not disconnect $\mathbb{C}(L)$. Therefore, a boundary link is in particular a homology boundary link. Let H be a genus 2 handlebody in S^3 .

- H is $(1)_S$ -*knotted* if it does not admit any planar spine, *i.e.* if it is knotted in the usual sense.

- A spine Γ of H is a *split spine* if there exists an embedded 2–sphere Σ in S^3 that intersects Γ transversely at just one regular point of its isthmus (in particular, L_Γ is a split link). A handlebody H is $(2)_S$ -knotted if it does not admit any split spine.
- A spine Γ of H is a *boundary spine* if its constituent link L_Γ is a boundary link that admits a pair of disjoint Seifert surfaces whose interiors are contained in $S^3 \setminus \Gamma$. A handlebody H is $(3)_S$ -knotted if it does not admit any boundary spine.
- A spine Γ of H is a *homology boundary spine* if its constituent link L_Γ is a homology boundary link that admits a pair of disjoint generalized Seifert surfaces whose interiors are contained in $S^3 \setminus \Gamma$. A handlebody H is $(4)_S$ -knotted if it does not admit any homology boundary spine.

3.2. Link–defined instances of knotting. Let H be a genus 2 handlebody in S^3 .

- H is $(1)_L$ -knotted if there is not any *trivial link* $L_\Gamma \in \mathcal{L}(H)$.
- H is $(2)_L$ -knotted if there is not any *split link* $L_\Gamma \in \mathcal{L}(H)$.
- H is $(3)_L$ -knotted if there is not any *boundary link* $L_\Gamma \in \mathcal{L}(H)$.
- H is $(4)_L$ -knotted if there is not any *homology boundary link* $L_\Gamma \in \mathcal{L}(H)$.

3.3. The general structure of knotting levels. The following tautological result describes some obvious relations between the instances of knotting we have introduced.

Proposition 3.1. *For every k such that the following statements make sense, we have:*

$$\begin{aligned} H \text{ is } (k+1)_S \text{ - knotted} &\implies H \text{ is } (k)_S \text{ - knotted} \\ H \text{ is } (k+1)_L \text{ - knotted} &\implies H \text{ is } (k)_L \text{ - knotted} \\ H \text{ is } (k)_L \text{ - knotted} &\implies H \text{ is } (k)_S \text{ - knotted} . \end{aligned}$$

Hence, we have a few five–steps *staircases* of increasing levels of knotting going up from the $(1)_S$ -level to the $(4)_L$ -level, each one starting with a substring of spine–defined and ending with a substring of link–defined instances. To study the partial ordering mentioned in the Introduction, we should in particular:

- Show that every instance of knotting is non–empty.
- Clarify to which extent such staircases are *strictly* increasing.
- Study whether or not one can establish any implication between the instances $(k)_L$ and $(k)_S$.

Remark 3.2. The above $(*)_L$ -knotting conditions describe increasing levels of knotting of 2–component links. The fact that these conditions determine *strictly* decreasing sets of links is a classical result, which cannot be immediately translated into the context of handlebodies (for example, because of the considerations in Remark 2.2).

3.4. Levels of knotting: main results. The following Theorem summarizes our results about the relations between the instances of knottings we have introduced.

Theorem 3.3. *We have the following facts:*

$$\begin{aligned} H \text{ is } (1)_L \text{ - knotted} &\implies H \text{ is } (2)_S \text{ - knotted} \\ H \text{ is } (2)_L \text{ - knotted} &\implies H \text{ is } (3)_S \text{ - knotted} \\ H \text{ is } (3)_L \text{ - knotted} &\implies H \text{ is } (4)_L \text{ - knotted} \\ H \text{ is } (4)_L \text{ - knotted} &\iff H \text{ is } (4)_S \text{ - knotted} \\ H \text{ is } (3)_S \text{ - knotted} &\implies H \text{ is } (1)_L \text{ - knotted} \end{aligned}$$

The following diagram summarizes the results described in Proposition 3.1 and Theorem 3.3, that completely characterize the relations among the levels of knotting we have introduced (see Corollary 3.4). We have labelled every non-tautological arrow by a reference to the Proposition where the corresponding implication is proved.

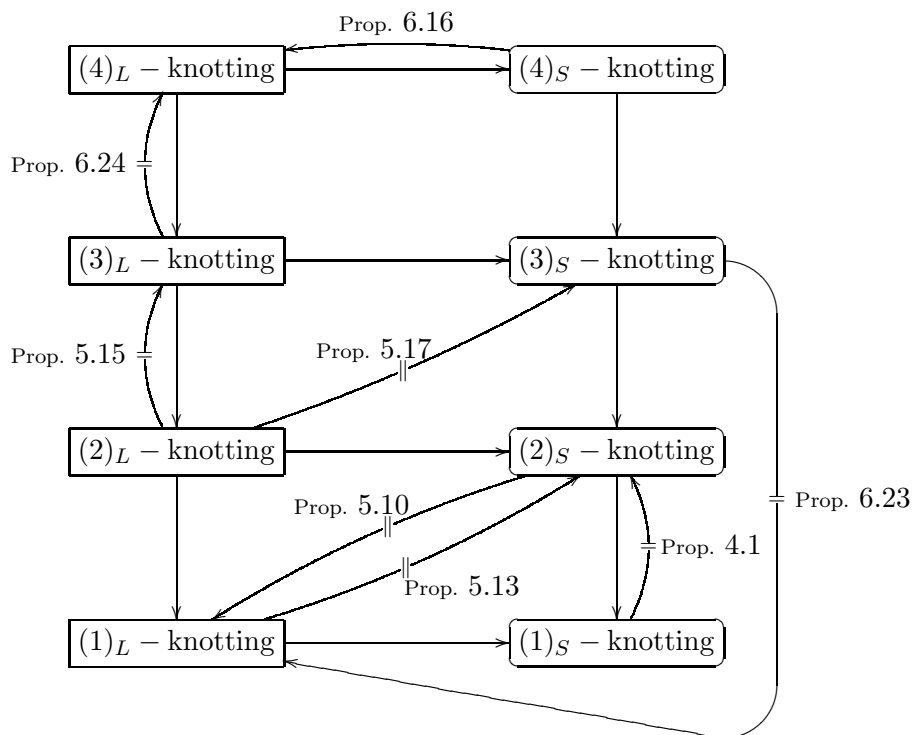

In Theorem 3.3 we did not mention the results proved in Propositions 4.1, 5.15 and 5.10 because, once the tautological statements of Proposition 3.1 are established, Proposition 4.1 is a consequence of Proposition 5.13, Proposition 5.15 is a consequence of Proposition 5.17, and Proposition 5.10 is a consequence of Proposition 6.23.

However, it is maybe worth mentioning that the arguments proving Propositions 4.1, 5.15 and 5.10 are independent, and sometimes quite different in nature, from the ones proving Propositions 5.13, 5.17, and 6.23. For example, the proof of Proposition 6.23 exploits the notion of *handlebody pattern* introduced in Subsection 6.5, while the proof of Proposition 5.10 relies on the use of quandle invariants. We also give a different proof of Proposition 6.23 in Proposition 8.18, where we exploit suitable obstructions coming from Alexander invariants.

In our opinion, a good reason for providing more proofs of some of our results is that the interplay of different techniques has been of help to us for figuring out the global picture of the space of knotted handlebodies.

Let us take two distinct instances of knottings $(k)_J$ and $(k')_{J'}$, where $J, J' \in \{L, S\}$ and $k, k' \in \{1, 2, 3, 4\}$. Then, putting together Proposition 3.1 and Theorem 3.3, one easily gets the following:

Corollary 3.4. *With the exception of the case $k_J = (4)_L$ and $(k')_{J'} = (4)_S$ (or viceversa), we have that*

$$(k)_J\text{-knotting} \implies (k')_{J'}\text{-knotting}$$

if and only if $(k')_{J'}$ -knotting descends from $(k)_J$ -knotting via a “staircase” chain of tautological implications (see Proposition 3.1).

By Theorem 3.3, the class of $(4)_L$ -knotted handlebodies coincides with the class of $(4)_S$ -knotted handlebodies. Corollary 3.4 tells us that, with this exception, the different instances of knotting we have introduced indeed describe distinct classes of spatial handlebodies.

In Theorem 3.13 below we also show that every instance of knotting is indeed non-empty, *i.e.* that there exist examples of $(4)_L$ -knotted (hence, $(k)_J$ -knotted for every $k = 1, \dots, 4$, $J \in \{L, S\}$) spatial handlebodies.

3.5. First remarks on unknotted and maximally knotted handlebodies. A $(1)_S$ -knotted H is knotted in the ordinary sense; recall that by Waldhausen's Theorem [54, 40] a spatial handlebody H is unknotted if and only if also $C(H)$ is a handlebody, *i.e.* if and only if H and $C(H)$ form a (genus 2) *Heegaard splitting of S^3* (which is unique up to isotopy).

On the opposite side, we have the following:

Lemma 3.5. *If $\text{cut}(C(H))$ is not maximal (i.e. not equal to 2), then H is $(4)_L$ -knotted.*

Proof. If H is not $(4)_L$ -knotted, then by definition there exists a link $L_\Gamma \in \mathcal{L}(H)$ which is homology boundary, so $\text{crk } \pi_1(C(L)) = 2$. By Lemma 3.6 below, this implies that $\text{crk } \pi_1(C(H)) = 2$, so $\text{cut}(C(H)) = 2$. \square

Lemma 3.6. *Let $L_\Gamma \in \mathcal{L}(H)$. Up to isotopy, we can assume that $C(H) \subset C(L_\Gamma)$. Then $i_* : \pi_1(C(H)) \rightarrow \pi_1(C(L_\Gamma))$ is an epimorphism. In particular, $\text{crk } \pi_1(C(H)) \geq \text{crk } \pi_1(C(L_\Gamma))$.*

Proof. By a general position argument it is easy to see that every loop in $S^3 \setminus L_\Gamma$ is homotopic to a loop that does not intersect the isthmus of Γ ; this easily implies that i_* is onto. \square

3.6. Cut systems. In this Subsection we provide a brief discussion of the notion of cut system, which will also allow us to sketch a proof of the well-known equality between the cut number of a manifold and the corank of its fundamental group. We focus on the special situation we are interested in, addressing the reader *e.g.* to [1] for a general and detailed discussion and the proofs.

Let M be equal either to $C(H)$ (where H is a genus-2 spatial handlebody) or to $C(L)$ (L being a 2-component link).

Definition 3.7. A *cut system* $\mathcal{S} = \{S_1, S_2\}$ of M is a pair of *disjoint* connected oriented surfaces properly embedded in M such that $M \setminus (S_1 \cup S_2)$ is connected.

We now list some classical well-known properties and characterizations of cut systems, also giving a hint about the proof of the equality $\text{cut}(M) = \text{crk } \pi_1(M)$ already mentioned in the Introduction. Let $\mathcal{S} = (S_1, S_2, \dots, S_k)$ be a set of disjoint connected oriented surfaces properly embedded in M . Then $M \setminus (S_1 \cup \dots \cup S_k)$ is connected if and only if S_1, \dots, S_k define linearly independent elements of $H_2(M, \partial M) \cong \mathbb{Z}^2$. In particular, if this is the case, then necessarily $k \leq 2$ (whence $\text{cut}(M) \leq 2$), and one can see that \mathcal{S} is a cut system (*i.e.* $k = 2$) if and only if S_1 and S_2 actually define a geometric basis of $H_2(M, \partial M)$. In this case, by Alexander duality, $\partial \mathcal{S} = \{\partial S_1, \partial S_2\}$ provides a geometric basis of $\ker i_*$, where i is the inclusion of the boundary ∂M into M (in particular, $\partial S_i \neq \emptyset$ for $i = 1, 2$). With a slight abuse, “ ∂ ” denotes here both the boundary homomorphism in the homology long exact sequence of the pair $(M, \partial M)$, and the geometric boundary of \mathcal{S} .

By definition, a link is homology boundary if and only if its complement admits a cut system. Something more can be achieved when considering classical boundary links. If M is the complement of a boundary link L , then it is easily seen that every pair of disjoint Seifert surfaces for the components of L define a basis of $H_2(M, \partial M)$, whence a cut system for M . Such a cut system enjoys the nice property that the boundaries of its surfaces are connected.

3.7. Cut number and corank. Since $\pi_1(M)/[\pi_1(M), \pi_1(M)] \cong H_1(M) \cong \mathbb{Z}^2$, it is easily seen that $1 \leq \text{crk } \pi_1(M) \leq 2$. In fact, one can prove that $\text{crk } \pi_1(M) = 2$ if and only if M maps onto the bouquet $S^1 \vee S^1$ of two circles via a map which induces a surjective homomorphism between the fundamental groups. An elementary instance of the Pontryagin–Thom construction may now be used to show that the required π_1 –surjective map between M and $S^1 \vee S^1$ exists if and only if M admits a cut system. Therefore, M admits a cut system if and only if $\text{crk } \pi_1(M) = 2$.

The argument just sketched may be easily generalized for showing that the equality $\text{cut}(N) = \text{crk } \pi_1(N)$ holds in fact for every compact 3–manifold N (and actually for every n –manifold, $n \in \mathbb{N}$, once one has replaced “surfaces” with “hypersurfaces” in the definition of cut number).

3.8. Cut systems and levels of knotting. Note that the two surfaces of a cut system of M (if any), have not necessarily connected boundary, and when $M = C(H)$, there could be also components of ∂S that separate $S = \partial M$. This suggests the existence of different intrinsic “levels of complication” of $M = C(H)$, which are defined in terms of the non–existence of cut systems having boundaries that satisfy some special conditions.

Definition 3.8. Let $\mathcal{S} = (S_1, S_2)$ be a cut system of $M = C(H)$. The *reduced boundary* $\partial_R S_j$ of S_j is made by the boundary components of S_j that do not separate $S = \partial M$. A cut system \mathcal{S} is said to be *∂ –connected* (resp. *∂_R –connected*) if both surfaces S_j have connected boundary (resp. connected reduced boundary).

We have proved in Lemma 3.5 that if M has no cut systems, then H is $(4)_L$ –knotted. The following Lemma provides more relations between the (non)existence of special cut systems for M and the knotting level of H .

Lemma 3.9. *Let $M = C(H)$. Then:*

- (a) *If M has no ∂ –connected cut systems, then H is $(3)_S$ –knotted.*
- (b) *If M has no ∂_R –connected cut systems, then H is $(3)_L$ –knotted.*

Proof. (a): Suppose H is $(3)_S$ –unknotted, and let Γ be a boundary spine for H . Then, the boundary link L_Γ admits disjoint Seifert surfaces that do not intersect the interior of the isthmus, thus defining also a cut system of M with connected boundaries.

(b): Suppose H is $(3)_L$ –unknotted, and let Γ be a spine for H with constituent boundary link L_Γ . Up to isotopy, we can assume that L_Γ admits a pair of disjoint Seifert surfaces that are transverse to the interior of the isthmus. Then the intersection of these surfaces with M form a cut system with connected reduced boundaries. \square

3.9. Boundary preserving maps onto handlebodies. Let W be a genus 2 handlebody. Following Lambert [30], we say that a continuous map $\varphi: M \rightarrow W$ is a $(M \rightarrow W)$ –*boundary–preserving–map* if $\phi|_S$ is a homeomorphism of $S = \partial H$ onto ∂W (such a ϕ is necessarily surjective).

The following result is proved in [30, Theorem 2].

Proposition 3.10. *Let $M = C(H)$. Then the following facts are equivalent:*

- (1) *M admits a ∂ –connected cut system.*
- (2) *There exists a $(M \rightarrow W)$ –boundary–preserving–map.*

In Sections 6 and 8 we describe some obstructions that prevent M to admit a ∂ –connected cut system. Such obstructions are obtained from the study of handlebody patterns as defined in Subsection 6.5, from the analysis of the maximal free covering of M , and from the study of the Alexander ideals of M .

3.10. Intrinsic and extrinsic knotting levels: main results. Let us underline that every property of H which can be expressed only in terms of the existence of cut systems of $C(H)$ (possibly with specific properties) does not depend on the embedding of H into S^3 , but is an intrinsic property of the complement of H . The question whether one can characterize the instances of knotting of H via intrinsic properties of $C(H)$ seems to be very difficult. An easy result in this context is described in Proposition 4.3, where it is shown that H is $(2)_S$ -knotted if and only if $M = C(H)$ is boundary-irreducible, *i.e.* it has incompressible boundary.

More difficult questions are suggested by Lemmas 3.5 and 3.9: is it possible to reverse the implications proved there? In Section 7 we obtain in particular the following interesting result:

Theorem 3.11. *$M = C(H)$ admits a ∂ -connected cut system if and only if H is not $(3)_S$ -knotted.*

The following result shows that the non-existence of cut systems satisfying *strictly* decreasingly demanding conditions actually corresponds to *strictly* increasing levels of (intrinsic) knotting.

Theorem 3.12. *We have the following facts:*

- (1) *There exist handlebody complements having incompressible boundary and admitting a ∂ -connected cut system.*
- (2) *There exist handlebody complements which do not admit any ∂ -connected cut system but admit a ∂_R -connected cut system.*
- (3) *There exist handlebody complements which do not admit any ∂_R -connected cut system but admit a generic cut system (*i.e.* they have cut number equal to 2).*

Proof. By Proposition 4.3 and Theorem 3.11, point (1) is equivalent to the fact that $(2)_S$ -knotting does not imply $(3)_S$ -knotting, which is a consequence of Corollary 3.4 (more precisely, Proposition 5.17 implies that there exist examples of $(3)_S$ -unknotted handlebodies which are $(2)_L$ -knotted, whence $(2)_S$ -knotted).

By Proposition 6.23, there exist $(1)_L$ -unknotted handlebodies whose complements do not admit any ∂ -connected cut system. By Lemma 3.9, every such complement admits a ∂_R -connected cut system, whence point (2).

Point (3) is a consequence of Proposition 6.24. □

Putting together Lemmas 3.5, 3.9 and Theorems 3.11, 3.12 we can summarize the relations between the intrinsic and extrinsic levels of knotting as follows:

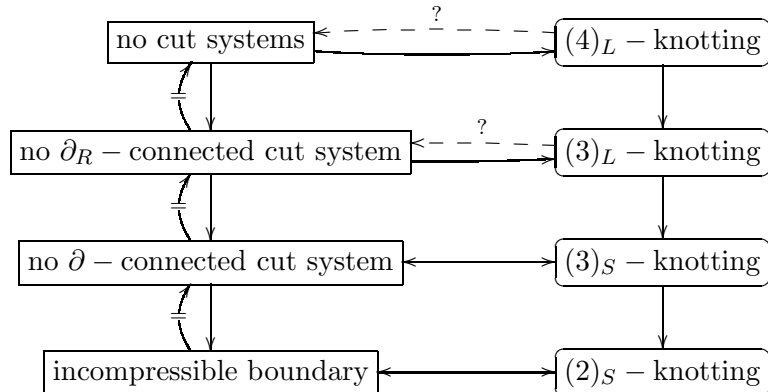

Let us now turn to the question whether every instance of knotting is non-empty. Of course, in order to give an affirmative answer to the question it is sufficient to show that there exist $(4)_L$ -knotted spatial handlebodies. As already mentioned in Lemma 3.5, if the complement of a spatial handlebody H has cut number equal to 1, then H is $(4)_L$ -knotted. Moreover, Jaco exhibited in [26] a spatial handlebody H such that $\text{cut}(\mathbb{C}(H)) = 1$, so every instance of knotting is non-empty. Following [46], in Section 8 we show how Alexander invariants can be used to provide obstructions for a handlebody complement to have maximal cut number. Moreover, in Subsection 8.15 we refine Jaco's result and prove the following:

Theorem 3.13. *There exist infinitely many non-isotopic spatial handlebodies $\{H_i\}_{i \in I}$ such that $\text{cut}(\mathbb{C}(H)) = 1$ for every $i \in I$. In particular, there exist infinitely many non-isotopic $(4)_L$ -knotted spatial handlebodies.*

4. ABOUT THE LOWER INSTANCES OF KNOTTING

Let H be a spatial handlebody, and set as usual $M = \mathbb{C}(H)$ and $S = \partial H = \partial M$. Recall that we denote by $\mathcal{S}(H)$ and $\mathcal{L}(H)$ the sets of isotopy classes respectively of (hc)-spines and constituent links of H .

Proposition 4.1. *Let $L_\Gamma \in \mathcal{L}(H)$. Then:*

- (1) *If L_Γ is a non-trivial homology boundary link, then H is $(1)_S$ -knotted.*
- (2) *Assume that H is unknotted. Then L_Γ is a homology boundary link if and only if the spine Γ is unknotted (i.e. planar).*
- (3) *$(1)_S$ -knotting does not imply $(2)_S$ -knotting.*

Proof. (1): Assume by contradiction that H is unknotted. Then also $\mathbb{C}(H)$ is a genus 2 handlebody, hence $\pi_1(\mathbb{C}(H)) = \mathbb{Z}^{*2}$. On the other hand, Papakyriakopolous' unknotting theorem for knots [38] (which is based on his "Loop Theorem") generalize to links (see for instance Theorem 1.1 in [21]), and implies that a n -component link is trivial if and only if the fundamental group of its complement is free on n generators. As a consequence, if we assume that L_Γ is a non-trivial homology boundary link, by Lemma 3.6 we could realize \mathbb{Z}^{*2} as a proper quotient of itself and this is not possible because \mathbb{Z}^{*2} is a Hopfian group [34].

(2): If H is unknotted, then by (1) a homology boundary $L_\Gamma \in \mathcal{L}(H)$ is necessarily trivial. Then we can apply the main theorem of [39] and conclude that the spine Γ itself is unknotted.

(3): Take a split (hc)-graph Γ with associated non-trivial split link L_Γ , and let H be a regular neighbourhood of Γ . By construction, H is not $(2)_S$ -knotted, while it is $(1)_S$ -knotted by (1). \square

Remark 4.2. The above Lemma can be rephrased by saying that the existence of a very special (i.e. unknotted) spine forces all the non-planar spines of an unknotted handlebody to be at the highest level of knotting (i.e. to have corresponding links which are not homology boundary).

The following Proposition provides a characterization of $(2)_S$ -knotting. It turns out that in spite of its definition, $(2)_S$ -knotting reflects an *intrinsic* property of M .

Proposition 4.3. *The following facts are equivalent:*

- (1) *H is $(2)_S$ -knotted.*
- (2) *$M = \mathbb{C}(H)$ has incompressible boundary (i.e. it is ∂ -irreducible).*
- (3) *$\pi_1(M)$ is not decomposable with respect to free products.*

Proof. The implication (2) \Rightarrow (3) is a consequence of the results proved in [25], and the implication (3) \Rightarrow (1) is trivial, so it is sufficient to show that (1) \Rightarrow (2).

So, we assume that M is boundary-compressible, and show that H admits a split spine. We follow the argument of [41, Theorem 4], getting here a stronger conclusion due to the fact that we are dealing with genus 2 handlebodies.

Let D be a properly embedded compressing 2-disk in M , such that ∂D is essential in $S = \partial H$. Of course, we may suppose that H does not determine a Heegaard splitting of S^3 (otherwise H is unknotted, and we are done). Then we can assume that D is disjoint from a suitable compressing disk E in H having boundary that does not non separate S (see [41, Lemma 3]). Compress H along E to obtain a solid torus H_1 , with boundary S_1 . If ∂D is not essential in S_1 , then ∂D bounds a disk D' also in H , so that the union of D and D' in a 2-sphere that splits a suitable split spine of H . If ∂D is essential in S_1 , then H_1 is unknotted and also in this case it is easy to conclude that H admits a split-spine. \square

Remark 4.4. Let us say that a (f8)-spine Γ is *tangled* if there does not exist any Whitehead move $\tilde{\Gamma} \rightarrow \Gamma$ such that $\tilde{\Gamma}$ is a split (hc)-spine. As far as we understand it, the statement of Proposition 4.1 of [17] is obtained from the statement of Proposition 4.3 above, just by replacing the first point with: “*There exists a tangled (f8)-spine of H .*”

Clearly this is a strictly weaker hypothesis: being $(2)_S$ -knotted is equivalent to require that *every* (f8)-spine is tangled. In fact, it is easy to show that an unknotted H actually admits both tangled and untangled (f8)-spines (see *e.g.* Figure 5), and that in this case $C(H)$ has compressible boundary indeed. Notice however that the arguments in [17] should provide a slightly different proof of Proposition 4.3.

The following Proposition is close in spirit to Remark 4.2.

Proposition 4.5. (a) *Let H be $(2)_S$ -knotted and not $(2)_L$ -knotted. Then, up to isotopy, there exists a unique (hc)-spine of H with split constituent link.*

(b) *If H is not $(2)_S$ -knotted then it admits a unique split spine, up to diffeomorphisms of S^3 that leave H invariant.*

Proof. (a): Let Γ_0, Γ_1 be (hc)-spines of H with split constituent links, and for $i = 1, 2$, take a separating meridian disk $D_i \subseteq H$ dual to the isthmus of Γ_i . Observe that by adding a 2-handle to $C(H)$ along D_i we obtain a reducible manifold, so Theorem 6.1 in [47] (see also [42]) implies that D_1 and D_2 may be isotoped to be disjoint. Since both D_1 and D_2 separate H , this easily implies that they are parallel in H , and this gives in turn that Γ_1 is isotopic to Γ_2 in H .

(b): Every split spine of H determines a sphere transversely intersecting ∂H in a simple closed curve that separates ∂H into two once-punctured tori. In the language of [52], such a sphere decomposes the pair $(S^3, \partial H)$ into its *prime factors*. Now, the main theorem in [52] ensures that the pair $(S^3, \partial H)$ admits a unique decomposition into prime factors, up to homeomorphism, and this concludes the proof. \square

5. QUANDLE COLORING OBSTRUCTIONS

New invariants of “links of spatial handlebodies” have been recently defined by Ishii in [23, 24]. Such invariants are based on the analysis of the possible colorings of diagrams, where colors are intended to belong to a *finite quandle of type k* (see below). For example, by using the simplest instance of these invariants, it has been remarked in [24] that the handlebody $H(\Gamma)$ corresponding to the spine Γ of Figure 7 is $(1)_S$ -knotted. This example also shows that $(1)_S$ -knottedness does not imply $(1)_L$ -knottedness. In fact, using quandle invariants we will show that

this $H(\Gamma)$ is $(2)_S$ -knotted (see Proposition 5.10), so that $(2)_S$ -knotted does not imply $(1)_L$ -knotted. We will come back to this example also in Proposition 6.23 and in Proposition 8.18, where we will give two different proofs of the fact that $H(\Gamma)$ is $(3)_S$ -knotted.

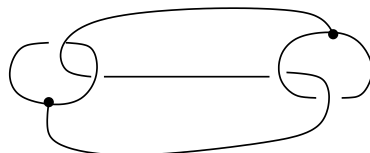

FIGURE 7. A $(3)_S$ -knotted $H(\Gamma)$ with trivial L_Γ .

We are going to show that by means of the same simplest quandle coloring invariants we can derive more information about our partial order on the instances of knotting. More precisely in this Section we prove the following:

Proposition 5.1. *Let H vary among the (genus 2) spatial handlebodies. Then:*

H is $(2)_S$ - knotted \iff H is $(1)_L$ - knotted	(see Proposition 5.10)
H is $(1)_L$ - knotted \iff H is $(2)_S$ - knotted	(see Proposition 5.13)
H is $(2)_L$ - knotted \iff H is $(3)_L$ - knotted	(see Proposition 5.15)
H is $(2)_L$ - knotted \iff H is $(3)_S$ - knotted	(see Proposition 5.17)

Preliminarily, we need to recall a few facts from [23, 24] that allow us to compute these invariants in our cases of interest: either for genus 2 handlebodies or for 2-component links.

5.1. Quandles: definitions and examples. A *quandle* $\mathbb{X} = (X, *)$ is a non-empty set X with a binary operation that verifies the following axioms. For every $a, b, c \in X$, we have:

- (Q1) $a * a = a$;
- (Q2) $(a * b) * c = (a * c) * (b * c)$;
- (Q3) $S_a(x) := x * a$ defines a bijection on X .

Notation: for every $a, b \in X$, for every $m \in \mathbb{N}$, set

$$a *^0 b = a, \quad a *^1 b = a * b, \quad a *^2 b = (a * b) * b, \quad a *^m b = (a *^{m-1} b) * b .$$

A quandle $(X, *)$ is *of type* $k \geq 2$ if k is the minimum positive integer such that for every $a, b \in X$, we have $a *^k b = a$.

Dihedral quandles. In a sense, the simplest quandles are the *m-dihedral quandles* $(R_m, *)$ defined as follows. We identify the ring $\mathbb{Z}_m := \mathbb{Z}/m\mathbb{Z}$ with the set $\{0, 1, \dots, m-1\}$ of canonical representatives, and it is understood that the operations act on this concrete set of integer numbers. Then, as a set $R_m = \mathbb{Z}_m$, while the quandle operation $*$ is defined in terms of the usual ring operations by: $a * b = 2b - a$. It is immediate that $(R_m, *)$ is a *finite quandle of type 2*. The name is justified by the fact that $(R_m, *)$ can be identified with the set of reflections of a regular m -gon with conjugation as quandle operation.

Tetrahedral quandle. Another important simple example is the *tetrahedral quandle* $(S_4, *)$, where as a set $S_4 = \mathbb{Z}_2[t, t^{-1}]/(t^2 + t + 1)$, and the quandle operation is defined in terms of the usual ring operations by: $a * b = ta + (1 - t)b$. It is easy to verify that this is a *finite quandle of type 3*.

Alexander quandle. The above examples belong to the class of so called *Alexander quandles* $(M, *)$ defined as follows. Let $\Lambda := \mathbb{Z}[t, t^{-1}]$. Consider any Λ -module M , as a set, with

a quandle operation $*$ defined (in terms of the usual operations on the Λ -module M) by $a * b = ta + (1 - t)b$. For every positive integer $m \geq 2$ and every Laurent polynomial $h(t) \in \mathbb{Z}[t, t^{-1}]$, the module $M_m = \mathbb{Z}_m[t, t^{-1}]/h(t)$ is an example of Alexander quandle. The quandle $(M_m, *)$ is finite if the coefficients of the highest and lowest degree terms are units in \mathbb{Z}_m . Also observe that the dihedral quandle $(R_m, *)$ introduced above is isomorphic to the Alexander quandle $(M_m, *)$ associated to the polynomial $h(t) = t + 1$.

5.2. Quandle coloring invariants. We are ready to describe the quandle coloring invariants. Let us fix a finite quandle $\mathbb{X} = (X, *)$ of type k .

Let us consider either an (hc)-spine Γ of a genus 2 handlebody H , or a 2-component link L . Fix an ordering and an auxiliary orientation ω of the two components K_1, K_2 of L_Γ (resp. L).

A \mathbb{Z}_k -cycle on (Γ, ω) (resp. on (L, ω)) associates to the isthmus of Γ the value $0 \in \mathbb{Z}_k$, and takes an arbitrary value $z_i \in \mathbb{Z}_k$ on K_i for $i = 1, 2$. Therefore, every (hc)-spine and every link supports exactly k^2 different \mathbb{Z}_k -cycles, encoded by the couples $z = (z_1, z_2)$ (the 0-value associated to the isthmus being understood).

Let \mathcal{D} be a given diagram of Γ (resp. L). Clearly the orientation ω and any \mathbb{Z}_k -cycle $z = (z_1, z_2)$ descend on \mathcal{D} . An *arc* of \mathcal{D} is an embedded curve in \mathcal{D} having as endpoints either an under-crossing or a vertex of Γ .

By definition, a \mathbb{X} -coloring of (\mathcal{D}, ω, z) assigns to each arc e of \mathcal{D} an element $a(e) \in X$, in such a way that at each crossing or vertex of \mathcal{D} the conditions shown in Figure 8 are satisfied.

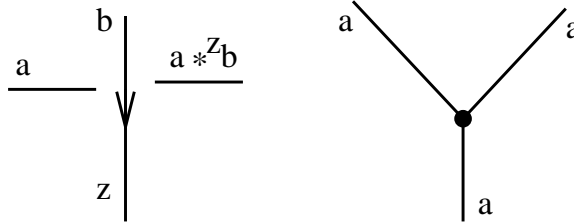

FIGURE 8. Quandle coloring.

Let us denote by $C_{\mathbb{X}}(\mathcal{D}, \omega, z)$ the number of such \mathbb{X} -colorings. Then, by varying the \mathbb{Z}_k -cycle z , we obtain a *non-ordered* k^2 -uple of positive integers denoted by $C_{\mathbb{X}}(\mathcal{D}, \omega)$.

By analyzing the behaviour of $C_{\mathbb{X}}(\mathcal{D}, \omega)$ under the spine moves, it is proved in [24] that $C_{\mathbb{X}}(\mathcal{D}, \omega)$ does not depend on the choice of the orientation ω (so that it makes sense to denote it by $C_{\mathbb{X}}(\mathcal{D})$), nor on the choice of the diagram \mathcal{D} , and not even on the choice of the (hc)-spine Γ of H . It follows that:

Proposition 5.2. *If Y is either a genus 2 spatial handlebody H or a 2-component link L , and \mathcal{D} is a diagram of either any (hc)-spine Γ of H or of L , then*

$$C_{\mathbb{X}}(Y) := C_{\mathbb{X}}(\mathcal{D}) \in \mathbb{N}^{k^2} / \mathfrak{S}_{k^2}$$

is a well defined isotopy invariant of Y (where \mathfrak{S}_{k^2} is the group of permutations on k^2 elements).

5.3. Specializing to the dihedral quandles. Let us concentrate our attention on the dihedral quandle $\mathbb{X} = (R_p, *)$, assuming also for simplicity that p is an odd prime number. Then:

- (1) As $\mathbb{X} = (R_p, *)$ is of type 2, the orientation ω is unessential in the definition of colorings, so we can forget about it.
- (2) Let a be the number of arcs of a diagram \mathcal{D} as above. Then, for every \mathbb{Z}_2 -cycle z on \mathcal{D} , the corresponding set of colorings is a linear subspace of \mathbb{Z}_p^a , determined by a linear equation at each crossing and at each vertex of \mathcal{D} . Hence $C_{\mathbb{X}}(\mathcal{D}, z)$ is a power of p , say p^d , $d = d(\mathcal{D}, z)$, where $d \leq a$.
- (3) For every \mathbb{Z}_2 -cycle z as above, the corresponding space of colorings contains the 1-dimensional subspace made by the constant colorings, so that $d(\mathcal{D}, z) \geq 1$.

By using the above remarks we can collect the information carried by the invariant $C_{\mathbb{X}}(Y)$ by means of the following invariant polynomial:

$$\Phi_p(Y)(t) := \Phi_p(\mathcal{D})(t) = \sum_z t^{d(\mathcal{D}, z)-1} \in \mathbb{N}[t] .$$

We stress that this notation could be a bit misleading as it could suggest that the monomials of $\Phi_p(Y)(t)$ are in some way marked by the \mathbb{Z}_2 -cycles. This is true for a given diagram, but this information is lost when we consider the polynomial as an invariant of Y . This corresponds to the fact that $C_{\mathbb{X}}(Y)$ is a *non*-ordered 4-tuple of positive integers. Clearly $\Phi_p(Y)(t)$ has at most 4 monomials, the sum of its coefficients is equal to 4, and its degree is at most $A - 1$, where A is the minimal number of arcs, when \mathcal{D} varies among all the diagrams of Y (when Y is a link) or of all the (hc)-spines of Y (when Y is a handlebody).

Lemma 5.3. *For every diagram \mathcal{D} of a (hc)-spine Γ of H (resp. of a 2-component link L) we have that $d(\mathcal{D}, (0, 0)) = 1$ (resp. $d(\mathcal{D}, (0, 0)) = 2$).*

Proof. Let \mathcal{D} be the diagram of a (hc)-spine Γ (resp. of a 2-component link L). Then, the assignment of a color to each arc defines a coloring of \mathcal{D} associated to the trivial cocycle if and only if it is constant (resp. it is constant on the components of L). \square

5.4. Quandle obstructions. Let p be an odd prime. From now on, we will consider only the dihedral quandle $\mathbb{X} = (R_p, *)$. By using the simplest quandle invariants associated to \mathbb{X} we are going to determine necessary conditions (“obstructions”) for a given H to be $(2)_S$ -unknotted, $(1)_L$ -unknotted or $(2)_L$ -unknotted. The following Lemma is not strictly necessary to our purposes (in fact, the statement of Corollary 5.5 regarding $(1)_L$ -unknotted handlebodies may also be deduced by Lemma 5.7 below – see Remark 5.8). However, it establishes an interesting relation between the quandle invariants of a handlebody and those of its constituent links. Throughout the whole Subsection, let H be a spatial handlebody.

Lemma 5.4. *Let $\Gamma \in \mathcal{S}(H)$ and take the corresponding $L_\Gamma \in \mathcal{L}(H)$. If*

$$\Phi_p(L_\Gamma)(t) = t + t^{m_1} + t^{m_2} + t^{m_3}, \quad m_1 \leq m_2 \leq m_3 ,$$

then there exist $n_1, n_2, n_3 \in \mathbb{N}$ such that

$$\Phi_p(H)(t) = 1 + t^{n_1} + t^{n_2} + t^{n_3}, \quad n_1 \leq n_2 \leq n_3 ,$$

and for $j = 1, 2, 3$ the integer n_j is such that either $n_j = m_j$ or $n_j = m_j - 1$.

Proof. We can take a diagram \mathcal{D} of Γ such that an open neighbourhood of the isthmus in Γ bijectively projects onto its image in \mathcal{D} . We can also ask that this image does not intersect the remaining part of the diagram. It follows that by removing the interior of the isthmus

from \mathcal{D} we get a diagram \mathcal{D}' of L_Γ . Then it is clear that, for every cycle z , the linear system computing $C_{\mathbb{X}}(\mathcal{D}, z)$ is obtained from the linear system computing $C_{\mathbb{X}}(\mathcal{D}', z)$ just by adding one equation due to the coloring conditions at vertices. Since both these linear systems admit the constant solutions, for every fixed cycle the set of solutions corresponding to \mathcal{D} is an affine subspace of codimension 0 or 1 of the space of solutions corresponding to \mathcal{D}' .

Together with Lemma 5.3, this shows that if $\Phi_p(L_\Gamma)(t) = t + t^{m_1} + t^{m_2} + t^{m_3}$, $m_1 \leq m_2 \leq m_3$, then there exist $n_1, n_2, n_3 \in \mathbb{N}$, $n_1 \leq n_2 \leq n_3$, such that $\Phi_p(H)(t) = 1 + t^{n_1} + t^{n_2} + t^{n_3}$ and $m_j - 1 \leq n_{\tau(j)} \leq m_j$, where $\tau \in \mathfrak{S}_3$ is a permutation. In order to conclude, it is now sufficient to show that we may assume that τ is the identity. But this is a consequence of the following easy

Claim: Let $a_1 \leq \dots \leq a_n$ and $b_1 \leq \dots \leq b_n$ be non-decreasing sequences of real numbers such that $b_i - 1 \leq a_{\tau(i)} \leq b_i$ for every $i = 1, \dots, n$, where $\tau \in \mathfrak{S}_n$ is a permutation. Then, we have $b_i - 1 \leq a_i \leq b_i$ for every $i = 1, \dots, n$.

In fact, for every given i_0 , the assumption implies that the set $\{i \mid a_i \leq b_{i_0}\}$ contains at least i_0 elements, so $a_{i_0} \leq b_{i_0}$. In the very same way one can show that $a_{i_0} \geq b_{i_0} - 1$, whence the conclusion. \square

Corollary 5.5. *Let $L \in \mathcal{L}(H)$ be a constituent link of H . Then,*

$$\deg \Phi_p(L) - 1 \leq \deg \Phi_p(H) \leq \deg \Phi_p(L).$$

In particular, if H is $(1)_L$ -unknotted, then $\deg \Phi_p(H) \leq 1$.

Proof. The first statement is an immediate consequence of the previous Lemma. If H is $(1)_L$ -unknotted, then the trivial link L belongs to $\mathcal{L}(H)$. Since $\Phi_p(L) = 4t$, the conclusion follows. \square

We now come to the obstruction to being $(2)_S$ -unknotted.

Lemma 5.6. *If H is not $(2)_S$ -knotted, then there exist $h_1, h_2 \in \mathbb{N}$ such that*

$$\Phi_p(H)(t) = 1 + t^{h_1} + t^{h_2} + t^{h_1+h_2}.$$

Proof. Since H admits a split (hc)-spine Γ , it has a diagram \mathcal{D} of the form shown in Figure 9, where it is understood that removing the interior of the isthmus one gets diagrams \mathcal{D}_j of the constituent knots K_j , $j = 1, 2$, so that every box includes a 1-string sub-diagram of the corresponding \mathcal{D}_j . The symbol a belongs to $R_p = \{0, 1, 2, \dots, p-1\}$ and refers to a portion of a \mathbb{X} -coloring of \mathcal{D} . For every \mathbb{Z}_2 -cycle $z = (z_1, z_2)$ on \mathcal{D} , every \mathbb{X} -coloring of (\mathcal{D}, z) restricts to a \mathbb{X} -coloring of both the diagrams (\mathcal{D}_j, z_j) .

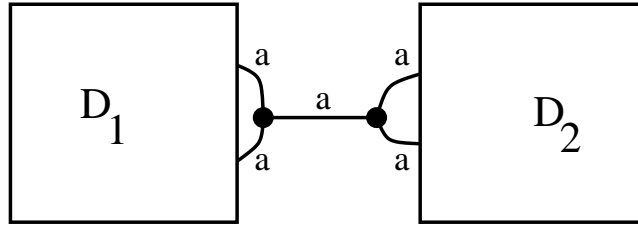

FIGURE 9. A $(2)_S$ -unknotted diagram.

For every $a \in R_p$ and $j = 1, 2$, denote by $n_{j,a} \in \mathbb{N}$ the number of \mathbb{X} -colorings of $(\mathcal{D}_j, 1)$ that extend the color a near the vertex of \mathcal{D} contained in \mathcal{D}_j . Then we have

$$C_{\mathbb{X}}(\mathcal{D}, (1, 0)) = \sum_a n_{1,a}$$

$$C_{\mathbb{X}}(\mathcal{D}, (0, 1)) = \sum_a n_{2,a}$$

$$C_{\mathbb{X}}(\mathcal{D}, (1, 1)) = \sum_a n_{1,a} n_{2,a} .$$

Due to the definition of the dihedral quandle, since $p \neq 2$, for every given $a, c \in R_p$ there exists a unique b such that $a * b = c$. Moreover, thanks to the axioms in the definition of quandles, if $b \in \mathbb{X}$ is a fixed color and we replace by $d * b$ every color d occurring in a \mathbb{X} -coloring of $(\mathcal{D}_j, 1)$ that takes the value a near the vertex, then we get an \mathbb{X} -coloring that takes the value c near the vertex. As a consequence, for $j = 1, 2$ there exists $h_j \in \mathbb{N}$ such that $n_{j,a} = p^{h_j}$ for every $a \in \mathbb{X}$.

It follows that we have

$$\begin{aligned} C_{\mathbb{X}}(\mathcal{D}, (0, 0)) &= p , & C_{\mathbb{X}}(\mathcal{D}, (1, 0)) &= p^{h_1+1} , \\ C_{\mathbb{X}}(\mathcal{D}, (0, 1)) &= p^{h_2+1} , & C_{\mathbb{X}}(\mathcal{D}, (1, 1)) &= p^{h_1+h_2+1} , \end{aligned}$$

whence the conclusion. \square

Lemma 5.7. *Suppose that H is $(2)_L$ -unknotted. Then there exist $h_1, h_2, h_3 \in \mathbb{N}$ such that*

$$\Phi_p(H)(t) = 1 + t^{h_1} + t^{h_2} + t^{h_3}, \quad h_1 \leq h_2 \leq h_3,$$

where $h_3 = h_1 + h_2$ or $h_3 = h_1 + h_2 + 1$. Moreover, if $L \in \mathcal{L}(H)$ is a split link, then

$$\Phi_p(L)(t) = t + t^{h_1+1} + t^{h_2+1} + t^{h_1+h_2+1} .$$

Proof. Let us take a spine Γ of H such that L_Γ is a split link. Then there is a diagram \mathcal{D} of Γ of the form shown in Figure 10. Here $h = 2n + 1$ is an odd positive integer and the rectangle in the middle represents h parallel strings. All the $h + 2$ horizontal strings belong to the isthmus. If we remove the interior of the isthmus we obtain a split diagram $\mathcal{D}_1 \cup \mathcal{D}_2$ of $L_\Gamma = K_1 \cup K_2$.

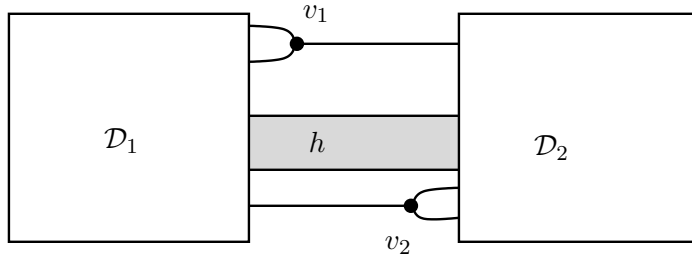

FIGURE 10. A $(2)_L$ -unknotted diagram.

For $i = 1, 2$, let C_i be the number of colorings of \mathcal{D}_i corresponding to the non-trivial cycle on \mathcal{D}_i , and let $h_1, h_2 \in \mathbb{N}$ be such that $C_i = p^{h_i+1}$. Since any \mathbb{Z}_2 -cycle on Γ vanishes on the isthmus, we easily get

$$\begin{aligned} C_{\mathbb{X}}(\mathcal{D}_1 \cup \mathcal{D}_2, (0, 0)) &= p^2 , & C_{\mathbb{X}}(\mathcal{D}, (0, 0)) &= p , \\ C_{\mathbb{X}}(\mathcal{D}_1 \cup \mathcal{D}_2, (1, 0)) &= p^{h_1+2} , & C_{\mathbb{X}}(\mathcal{D}, (1, 0)) &= p^{h_1+1} , \\ C_{\mathbb{X}}(\mathcal{D}_1 \cup \mathcal{D}_2, (0, 1)) &= p^{h_2+2} , & C_{\mathbb{X}}(\mathcal{D}, (0, 1)) &= p^{h_2+1} , \\ C_{\mathbb{X}}(\mathcal{D}_1 \cup \mathcal{D}_2, (1, 1)) &= p^{h_1+h_2+2} . \end{aligned}$$

This implies in particular that

$$\Phi_p(L)(t) = t + t^{h_1+1} + t^{h_2+1} + t^{h_1+h_2+1} .$$

Observe now that every $(1, 1)$ -coloring of \mathcal{D} restricts to a $(1, 1)$ -coloring of $\mathcal{D}_1 \cup \mathcal{D}_2$. Moreover, once a $(1, 1)$ -coloring of $\mathcal{D}_1 \cup \mathcal{D}_2$ is fixed, one can try to extend it to a $(1, 1)$ -coloring of \mathcal{D} as follows: the coloring of \mathcal{D}_1 uniquely determines the color of the arc of the isthmus starting at the vertex v_1 ; then, following the isthmus from v_1 to v_2 , one assigns to the arcs of the isthmus the colors uniquely determined by the rules describing the behaviour of colorings at crossings; finally, one check whether the color obtained at the arc ending at v_2 matches the fixed coloring of \mathcal{D}_2 . One can express this last condition as a linear equation on the colors of $\mathcal{D}_1 \cup \mathcal{D}_2$, and this implies in turn that the set of $(1, 1)$ -colorings of \mathcal{D} admits a bijection with a subspace of the $(1, 1)$ -colorings of $\mathcal{D}_1 \cup \mathcal{D}_2$ having codimension 0 or 1. Then $C_{\mathbb{X}}(\mathcal{D}, (1, 1))$ is equal either to $p^{h_1+h_2+2}$ or to $p^{h_1+h_2+1}$, whence the conclusion. \square

Remark 5.8. If L is the trivial link, then $\Phi_p(t) = 4t$. Therefore Lemma 5.7 allows us to refine Corollary 5.5: if H is $(1)_L$ -unknotted, then we have either $\Phi_p(H) = 4$ or $\Phi_p(H) = 3+t$.

Our next goal is to use the so obtained obstructions in order to produce, for example, families of $(2)_S$ -knotted (resp. $(2)_L$ -knotted) handlebodies that are $(2)_L$ -unknotted (resp. $(3)_L$ -unknotted, and even $(3)_S$ -unknotted). Having this in mind, it is useful to introduce and study some elementary tangles that we will combine in order to get the desired examples.

5.5. The tangle $E(q)$. Let q be an odd prime, and consider the tangle $E(q)$ of Figure 11. Here q is an odd positive integer, the $z_i \in \mathbb{Z}_2$, $i = 1, 2$, label the horizontal lines and play the rôle of a \mathbb{Z}_2 -cycle z , while the colors a, b, c_j belong to R_p and refer to a generic \mathbb{X} -coloring of this tangle, relative to the given $z = (z_1, z_2)$. Recall that our assumptions imply that every cycle vanishes on the isthmus, so for every z any admissible coloring is constant on the horizontal lines. As a consequence, a (resp. b) are constant along the top (resp. bottom) line of the diagram.

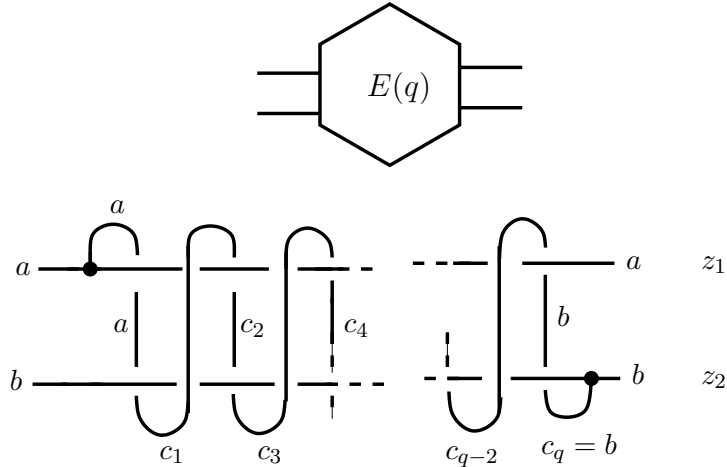

FIGURE 11. The tangles $E(q)$.

The following Lemma computes the number of colorings of the tangle $E(q)$.

Lemma 5.9. For every p denote by $C_p E(q, z, a, b)$ the number of $(R_p, *)$ -colorings of $E(q)$ relative to z which assume the values a and b respectively on the top and the bottom line of the diagram. Then:

- (1) If $q = p$ and $z = (1, 1)$, then $C_p E(q, z, a, b) = 1$ for every $(a, b) \in R_p^2$.

- (2) In all the other cases (i.e. if $p \neq q$ or if $z \neq (1, 1)$), then $C_p E(q, z, a, b) = 0$ if $a \neq b$, and $C_p E(q, z, a, b) = 1$ if $a = b$ (and in this case, we have only the constant coloring assigning the color $a = b$ to every arc of the diagram).

Proof. Let us consider only the case $z = (1, 1)$, the other cases being easier. With notation as in Figure 11, we have $c_1 = a * b = 2b - a$, and $c_{2l+1} = (c_{2l-1} * a) * b = c_{2l-1} + 2(b - a)$ for every $l = 1, \dots, (q - 1)/2$. We get therefore $c_q = (q - 1)(b - a) + 2b - a$, and the assigned coloring of the horizontal rows extends (in a unique way) to the whole diagram if and only if $(q - 1)(b - a) + 2b - a = b$, i.e. if and only if $q(b - a) = 0$. This equality holds in \mathbb{Z}_p if and only if p divides q or $a = b$, whence the conclusion. \square

5.6. **(2)_S-knotting does not imply (1)_L-knotting.** We are ready to construct the first pertinent family of examples. For every odd prime p , consider the (hc)-spines $\Gamma_1(p)$ of Figure 12, and set $H_1(p) = H(\Gamma_1(p))$.

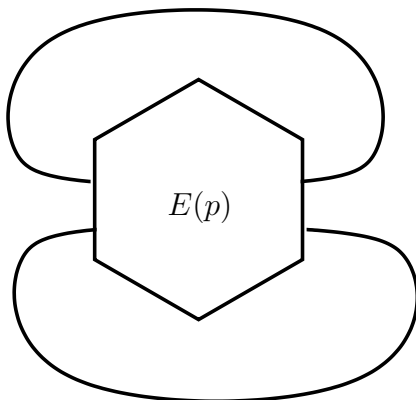

FIGURE 12. The spine $\Gamma_1(p)$. The hexagonal box represents the tangle described in Figure 11.

Proposition 5.10. *For every prime p , $H_1(p)$ is (2)_S-knotted and (1)_L-unknotted. Moreover, if p and p' are different prime numbers, then $H_1(p)$ and $H_1(p')$ are not isotopic.*

Proof. Let p be a fixed prime number. Since the constituent link of $\Gamma_1(p)$ is trivial, by definition $H_1(p)$ is not (1)_L-knotted.

An easy application of Lemma 5.9 implies that the numbers of distinct $(R_p, *)$ -colorings of $\Gamma_1(p)$ with respect to the cycle $z = (z_1, z_2)$ is equal to p^2 if $z = (1, 1)$ and to p otherwise. This implies that

$$\Phi_p(H_1(p))(t) = 3 + t .$$

Together with Lemma 5.6, this implies that $H_1(p)$ is (2)_S-knotted.

Take now a prime number $p' \neq p$. Lemma 5.9 now easily implies that $\Phi_p(H_1(p'))(t) = 4 \neq \Phi_p(H_1(p))(t)$, so $H_1(p')$ is not isotopic to $H_1(p)$. \square

Remark 5.11. Building respectively on the theory of handlebody patterns developed in Section 6 and on the use of Alexander-type invariants, in Propositions 6.23 and 8.18 we give two different proofs of the stronger fact that $H_1(p)$ is (3)_S-knotted for every prime p .

5.7. **The tangle $O(q)$.** We now consider the tangle $O(q)$ of Figure 13, which can be obtained from $E(q)$ as follows: first, we attach to the band bounded by the two horizontal lines of $E(q)$ a 2-dimensional 1-handle whose core coincides with the isthmus; then, we define $O(q)$ to be the boundary of the so obtained surface. Observe that $O(q)$ is the union of two arcs, one of which is entering and exiting the diagram on the left, the other on the right.

In what follows, we will be interested in the colorings of $O(q)$ corresponding to \mathbb{Z}_2 -cycles which either vanish on both the components of $O(q)$, or take the value 1 on both the components of $O(q)$. We denote the corresponding labelled tangles respectively by $O(q, 0)$ and $O(q, 1)$. We also denote by $a, b \in R_p$ a pair of “input” colors which are assigned to the arcs entering and exiting the diagram of $O(q)$ on the left (see Figure 13). The following Lemma describes the possible pairs of “output” colors $a', b' \in R_p$ which are associated to the entering/exiting arcs on the right by a global coloring that extends the “input” datum (a, b) .

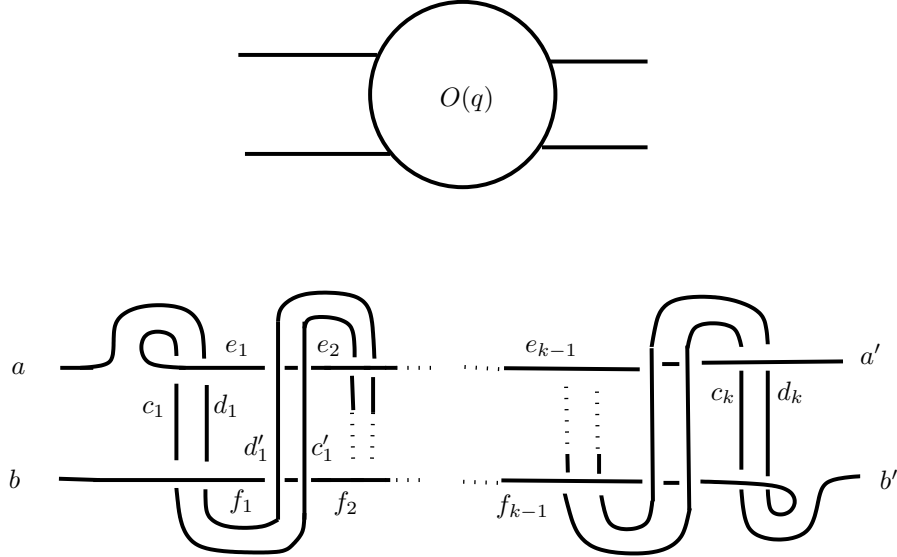

FIGURE 13. The tangles $O(q)$, where $q = 2k - 1$.

Lemma 5.12. For $z \in \{0, 1\}$ and q an odd prime, let $C_p O(q, z, a, b, a', b')$ be the number of $(R_p, *)$ -colorings of $O(q, z)$ that extend the given input/output data (a, b, a', b') .

- (1) Suppose that $p = q$. Then, $C_p O(q, 1, a, b, a', b') = p$ if $a = a'$ and $b = b'$, and $C_p O(q, 1, a, b, a', b') = 0$ if $a \neq a'$ or $b \neq b'$.
- (2) Suppose that $p \neq q$, and let us fix $(a, b) \in R_p^2$. Then there exists a unique pair $(a', b') \in R_p^2$ such that $C_p O(q, 1, a, b, a', b') = 1$. Moreover, if $a = a'$ or $b = b'$ then we have $a = a' = b = b'$. If $(a'', b'') \neq (a', b')$ is any other pair of colors, then $C_p O(q, 1, a, b, a'', b'') = 0$.
- (3) Suppose that $z = 0$. Then, we have $C_p O(q, 0, a, b, a', b') = 1$ if $a = b$ and $a' = b'$, and $C_p O(q, 0, a, b, a', b') = 0$ if $a \neq b$ or $a' \neq b'$.

Proof. Point (3) is obvious, so we concentrate our attention on the colorings of $O(q, 1)$.

Let us set $k = (q + 1)/2$, and label the vertical arcs of the diagram by the colors

$$c_1, d_1, \dots, c_k, d_k, c'_1, d'_1, \dots, c'_{k-1}, d'_{k-1}$$

as in Figure 13. Also label by the color e_i (resp. f_i) the top (resp. bottom) arc passing over the arcs labelled by c_i and d_i .

We set $x = c_1$, and look for the values that the labels introduced above must take in order to define a coloring of the diagram that extends the given input/output data. By looking at crossings from the left to the right we obtain

$$\begin{aligned} e_1 &= x, & f_1 &= b, & d_1 &= a * x = 2x - a, \\ c'_i &= c_i * f_i, & d'_i &= d_i * f_i, & i &= 1, \dots, k-1, \end{aligned}$$

and

$$e_{i+1} = (e_i * d'_i) * c'_i, \quad f_{i+1} = (f_i * d'_i) * c'_i, \quad c_{i+1} = c'_i * e_{i+1}, \quad d_{i+1} = d'_i * e_{i+1}$$

for every $i = 1, \dots, k-1$. Therefore, an easy induction shows that

$$(1) \quad \begin{aligned} e_k &= (2k-1)x - (2k-2)a, & f_k &= b + (2k-2)(x-a), \\ c_k &= (6k-5)x - (4k-4)a - (2k-2)b, & d_k &= (6k-4)x - (4k-3)a - (2k-2)b. \end{aligned}$$

Now, the fixed labels a, b, a', b', x extend (uniquely) to a coloring of the whole diagram if and only if

$$\begin{cases} e_k = a' \\ f_k = d_k \\ c_k * f_k = b' \end{cases}.$$

By (1), since $q = 2k-1$ this linear system is equivalent to the system

$$(2) \quad \begin{cases} qx - (q-1)a = a' \\ q(2x - a - b) = 0 \\ -qx + (q+1)b = b' \end{cases}.$$

Let us assume that $p = q$. Then, the system (2) reduces to the conditions $a = a', b = b'$. If these conditions are satisfied, every choice for x can be (uniquely) extended to a coloring of the diagram, while if $a \neq a'$ or $b \neq b'$ there do not exist colorings extending the input/output data a, a', b, b' . This proves point (1).

If $p \neq q$, then the second equation of (2) implies that $x = (a+b)/2$ (recall that p is odd, so that 2 is invertible in \mathbb{Z}_p). Then, looking at the other equations we see that the system admits a (unique) solution if and only if $2a' = (2-q)a + qb$ and $2b' = -qa + (q+2)b$. In particular, if $a = a'$ or $b = b'$ we necessarily have $a = a' = b = b'$, whence the conclusion. \square

5.8. (1)_L-knotting does not imply (2)_S-knotting. For every odd prime q , let us consider the graph $\Gamma_2(q)$ described in Figure 14, and let $H_2(q) = H(\Gamma_2(q))$.

We have the following:

Proposition 5.13. *For every prime p , $H_2(p)$ is (1)_L-knotted and (2)_S-unknotted. Moreover, if p and p' are different prime numbers, then $H_2(p)$ and $H_2(p')$ are not isotopic.*

Proof. Let us fix an odd prime number p' . It is clear that $\Gamma_2(p')$ is a split spine of $H_2(p')$, which is therefore (2)_S-unknotted. By Lemma 5.6 (and its proof), in order to compute $\Phi_p(H_2(p'))$ it is sufficient to compute the number of z -colorings of $H_2(p')$ for $z = (1, 0)$ and $z = (0, 1)$.

So, let us suppose that the cycle $z = (1, 0)$ assigns the value 1 (resp. 0) to the component of $L_{\Gamma_2(p')}$ on the top (resp. on the bottom) of Figure 14. An easy application of Lemma 5.12 shows that if $p \neq p'$, then the only (1, 0)-colorings of $\Gamma_2(p')$ are the constant ones. The same is true for (0, 1)-colorings, so by Lemma 5.6 we have

$$\Phi_p(H_2(p')) = 4 \quad \text{if } p \neq p'.$$

Suppose now $p = p'$. By Lemma 5.12 it is easily seen that the knot on the top of Figure 14 admits exactly p^3 colorings relative to the non-trivial cycle. Moreover, each such coloring

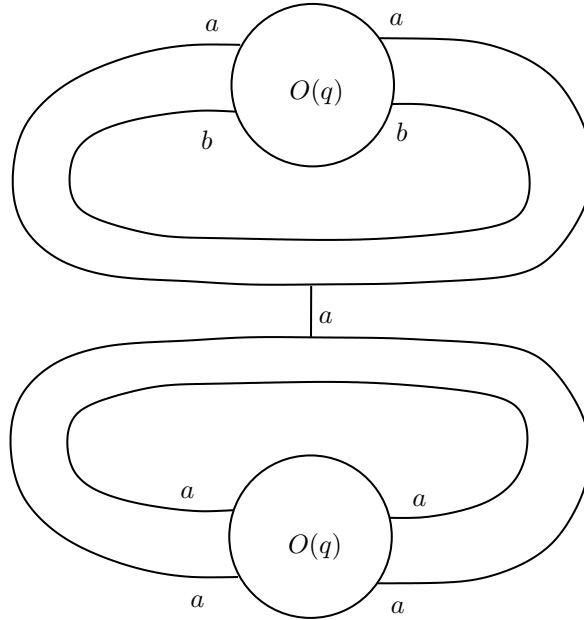

FIGURE 14. An R_p -coloring of the spine $\Gamma_2(q)$ relative to the cycle $(1, 0)$, when $p = q$. The circular boxes represent tangles as described in Figure 13.

uniquely extends to a $(1, 0)$ -coloring of the whole diagram of $\Gamma_2(p)$. By the symmetry of the diagram, the same result holds for $(0, 1)$ -colorings. Then, by Lemma 5.6 we have

$$\Phi_p(H_2(p)) = 1 + 2t^2 + t^4.$$

By Corollary 5.5, this implies that $H_2(p)$ is $(1)_L$ -knotted. Moreover, if $p' \neq p$ we have $\Phi_p(H_2(p)) \neq \Phi_p(H_2(p'))$, so the spatial handlebodies $H_2(p)$ and $H_2(p')$ are not isotopic. \square

5.9. Quandle colorings of bands. Our next constructions make an extensive use of links and tangles obtained by “doubling” some given knot or tangle, *i.e.* by replacing a knot or a tangle with the boundary of a band representing a fixed framing on the knot or the tangle. Therefore, it is convenient to point out some nice features of quandle colorings of bands.

So, let us consider a pair A of parallel arcs in a diagram, labelled with colors $a, b \in R_p$. After fixing a (coherent) orientation on the arcs, we suppose that a (resp. b) is the color of the arc running on the right (resp. on the left), and we set $\delta = b - a$. For reasons that will become clear soon, we label A by the pair $(a, \delta) \in R_p^2$ (see Figure 15).

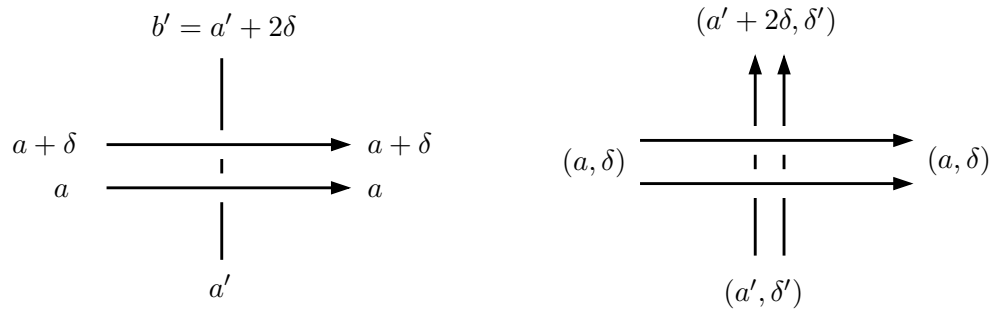

FIGURE 15. Quandle colorings of bands.

Let us now suppose that both the arcs of A are labelled by the non-trivial \mathbb{Z}_2 -cycle. Now, if an arc undercrosses the band A from the right (with color a') to the left (with color b'), it is immediate to observe that in order to have an admissible coloring the equality $b' = a' + 2\delta$ must hold. As a consequence, if a band A' undercrosses A from the right to the left, and the portion of A' on the right is labelled by (a', δ') , then the portion on the left has to be labelled by $(a' + 2\delta, \delta')$. In particular, the parameter δ' propagates without being affected by crossings.

5.10. **The tangle $\overline{O}(q)$.** Let us now consider the tangle $\overline{O}(q)$ obtained by replacing each arc of $O(q)$ with a band, thus obtaining a tangle with four strings. In Figure 16 we represent $\overline{O}(q)$ by drawing one arrow for each band. We agree that the $(1, 1)$ -cycle (resp. the $(0, 0)$ -cycle) assigns the value 1 (resp. 0) to every arc, the $(1, 0)$ -cycle (resp. $(0, 1)$ -cycle) assigns the value 1 (resp. 0) on the arcs giving the “right” boundary of the band (with respect to the orientation given by the arrows) and the value 0 (resp. 1) on the arcs on the left.

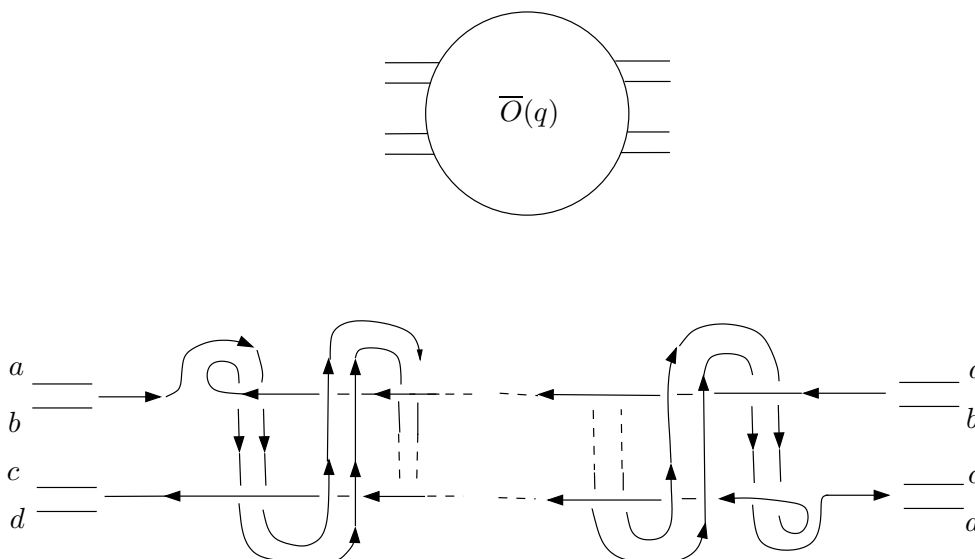

FIGURE 16. The tangle $\overline{O}(q)$.

Lemma 5.14. *For every p and $z \in \mathbb{Z}_2^2$ let us denote by $C_p \overline{O}(q, z, a, b, c, d)$ the number of $(R_p, *)$ -colorings of $\overline{O}(p)$ relative to the cycle z (in the sense specified above) that extend the coloring described in Figure 16. Then:*

- (1) *If $z = (1, 1)$, then $C_p \overline{O}(q, z, a, b, c, d) = 1$ if $a = d$ and $b = c$, and $C_p \overline{O}(q, z, a, b, c, d) = 0$ otherwise.*
- (2) *If $q = p$ and $z = (1, 0)$ or $z = (0, 1)$, then for every $a \in R_p$ we have $C_p \overline{O}(q, z, a, a, c, d) = p$ if $c = d$, and $C_p \overline{O}(q, z, a, a, c, d) = 0$ if $c \neq d$.*
- (3) *If $q \neq p$ and $z = (1, 0)$ or $z = (0, 1)$, then for every cycle z we have $C_p \overline{O}(q, z, a, a, c, d) = 1$ if $a = c = d$, and $C_p \overline{O}(q, z, a, a, c, d) = 0$ otherwise.*

Proof. (1): The discussion carried out in Subsection 5.9 shows that a necessary condition for extending the given coloring is that $b - a = c - d$. Let us set $b - a = c - d = \delta$. From the top to the bottom, we may label the bands on the left by $(b, -\delta)$ and $(c, -\delta)$, and the bands on the right by (a, δ) and (d, δ) . Since every band undercrosses itself and the other band the same number of times (with the same orientation), it follows that we need to have $a = d$ and

$b = c$. Moreover, it is clear that if this condition is satisfied, then the coloring extends in a unique way.

(2), (3): Independently of the cycle z , it is readily seen that if a coloring assigns the same color to two parallel arcs bounding a portion of a band, then every pair of parallel arcs belonging to that band must have the same color. Also observe that this is our case of interest, since we are assigning the color a on the top arcs both on the right and on the left of the diagram. If $z = (1, 0)$ or $z = (0, 1)$, this implies in turn that the z -colorings of $\overline{O}(q)$ bijectively correspond to the $(1, 1)$ -colorings of $O(q)$, *i.e.* the z -colorings of $\overline{O}(q)$ are exactly the colorings obtained by “doubling” a $(1, 1)$ -coloring of $O(q)$. The conclusion follows now from Lemma 5.12. \square

5.11. **(2)_L-knotting does not imply (3)_L-knotting.** For every odd prime q , let us consider the spine $\Gamma_3(q)$ shown in Figure 17, and set $H_3(q) = H(\Gamma_3(q))$. Let K_1, K_2 be the constituent knots of $\Gamma_3(q)$. For $i = 1, 2$, it is readily seen that the blackboard framing of K_i coincide with the trivial framing, and this implies that $L_{\Gamma_3(q)} = K_1 \cup K_2$ is a boundary link (since the linking number of the knots of K_1 and K_2 is zero, a parallel copy of a Seifert surface S_1 for K_1 provides a Seifert surface for K_2 which is disjoint from K_1).

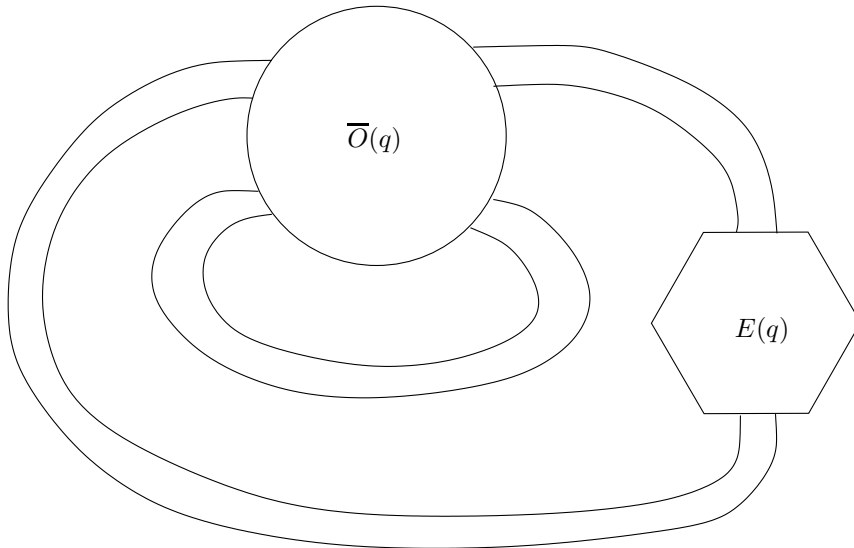

FIGURE 17. The spine $\Gamma_3(q)$.

Putting together Lemmas 5.9, 5.14 and 5.7 one easily gets the following:

Proposition 5.15. *If p, q are distinct odd primes, then*

$$\Phi_p(H_3(p)) = 1 + t + 2t^2, \quad \Phi_p(H_3(q)) = 4.$$

In particular, $H_3(p)$ is (2)_L-knotted and (3)_L-unknotted, and $H_3(p)$ is not isotopic to $H_3(q)$.

In Subsection 5.13 we prove the stronger result that (2)_L-knotting does not imply (3)_S-knotting. One may wonder if this result could be achieved just by replacing the hexagonal box $E(q)$ with the trivial box $E(1)$ in the construction of $\Gamma_3(q)$. An easy computation shows that this is not the case. More in general, let us take a knot K_1 with a diagram \mathcal{D} . Let us “double” \mathcal{D} by replacing each arc of \mathcal{D} with a band, and let us add an isthmus in the most trivial possible way, *i.e.* by adding an arc which is properly embedded in a small portion of a band, thus getting a (hc)-spine Γ .

If the blackboard framing defined by \mathcal{D} is equal to the trivial framing of K , then Γ is a boundary spine of $H(\Gamma)$. However, it is not difficult to show that for every prime p we have $\Phi_p(H(\Gamma)) = 2 + t^{h_p}$, where h_p is an integer depending on p . In particular, the form of $\Phi_p(H(\Gamma))$ does not allow us to use Lemma 5.7 in order to conclude that $H(\Gamma)$ is $(2)_L$ -knotted.

In the following Subsections, therefore, we slightly modify our strategy in order to get the desired handlebodies admitting a boundary spine but no split constituent link.

One could also wonder if $H_3(q)$ itself is indeed $(3)_S$ -knotted (*i.e.* if it does not admit *any* boundary spine). We prove that this is the case in Proposition 6.23.

5.12. The tangle B . Let us now consider the tangle B showed in Figure 18. Under the assumption that every arc is labelled with the non-trivial \mathbb{Z}_2 cycle, we would like to compute the number $C_p(a, b, c, d)$ of R_p -colorings of B which extend the colors a, b, c, d assigned on the ‘‘corners’’ of the diagram.

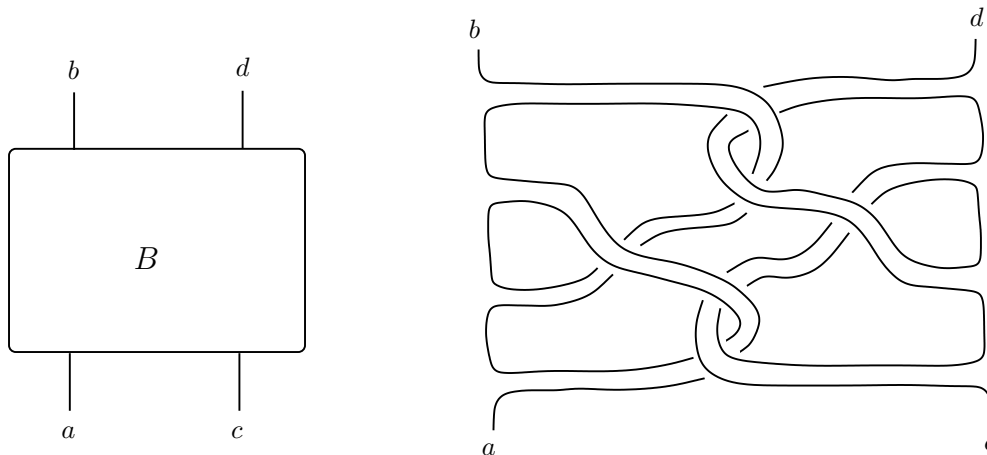

FIGURE 18. The tangle B .

Lemma 5.16. *We have*

$$\begin{cases} C_p(a, b, c, d) = p^2 & \text{if } a = b, c = d \text{ and } p = 3 \\ C_p(a, b, c, d) = 1 & \text{if } a = b, c = d \text{ and } p \neq 3 \\ C_p(a, b, c, d) = 0 & \text{otherwise.} \end{cases}$$

Proof. Let us orient the bands of B as in Figure 19. The condition on the colors of the arcs at the corners of B implies that the bands arriving at the corners of B have to be labelled by the pairs (a, δ_1) , (b, δ_2) , (c, δ_3) and (d, δ_4) , where $\delta_i \in R_p$ for every $i = 1, 2, 3, 4$. The discussion above shows that, due to the crossings of the bands, the pairs labelling the bands have to propagate as described in Figure 19. Since the arcs at the ends of the bands join in pairs as described on the sides of the figure, the input coloring (a, b, c, d) can be extended to a coloring of the whole B if and only if the following conditions hold:

$$\begin{aligned} a + \delta_1 &= b - 2\delta_4 + 2\delta_1, & b - 2\delta_4 + 2\delta_1 + \delta_2 &= a + 2\delta_3 + \delta_1, & a + 2\delta_3 &= b + \delta_2, \\ d + \delta_4 &= c - 2\delta_1 + 2\delta_4, & c - 2\delta_1 + 2\delta_4 + \delta_3 &= d + 2\delta_2 + \delta_4, & d + 2\delta_2 &= c + \delta_3. \end{aligned}$$

Such conditions may be rewritten as follows:

$$\begin{aligned} a - b &= \delta_1 - 2\delta_4 = \delta_1 - 2\delta_4 + \delta_2 - 2\delta_3 = \delta_2 - 2\delta_3 \\ d - c &= \delta_4 - 2\delta_1 = \delta_4 - 2\delta_1 + \delta_3 - 2\delta_2 = \delta_3 - 2\delta_2. \end{aligned}$$

This readily implies that $C_p(a, b, c, d) = 0$ whenever $a \neq b$ or $c \neq d$.

Let us suppose that $a = b$ and $c = d$. In this case, our conditions are equivalent to the equations

$$\delta_1 = 2\delta_4, \quad \delta_4 = 2\delta_1, \quad \delta_2 = 2\delta_3, \quad \delta_3 = 2\delta_2.$$

If $p \neq 3$, it is readily seen that this implies $\delta_i = 0$ for every $i = 1, \dots, 4$, so $C_p(a, a, c, c) = 1$. On the other hand, if $p = 3$ then the conditions above are equivalent to $\delta_1 = -\delta_4$ and $\delta_2 = -\delta_3$, so the desired colorings bijectively correspond to the choices of $(\delta_1, \delta_2) \in \mathbb{R}_3^2$, whence the conclusion. \square

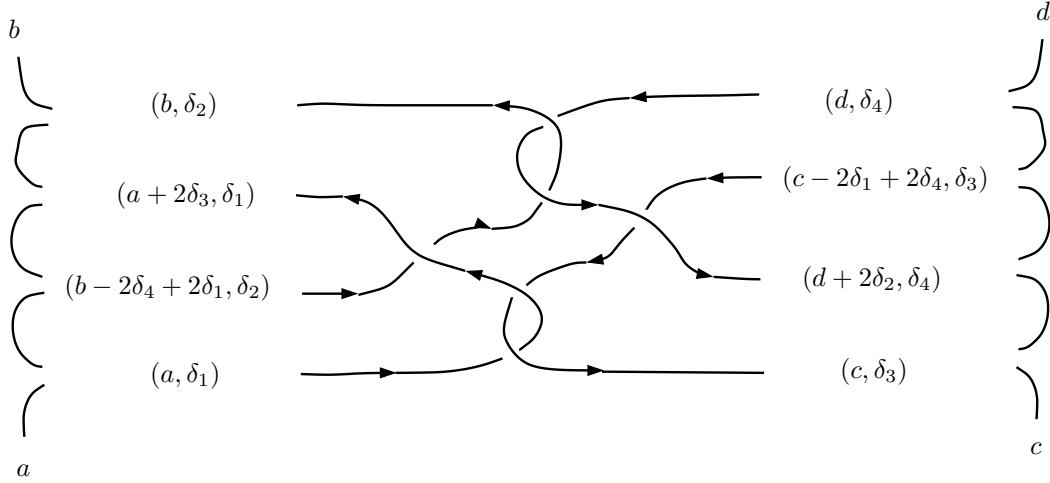

FIGURE 19. Colorings of B . Every arrow represents a band.

5.13. **(2)_L-knotting does not imply (3)_S-knotting.** We are now ready to construct examples of spatial handlebodies which are (2)_L-knotted (*i.e.* they do not admit a spine with split constituent link) but (3)_S-unknotted (*i.e.* they admit a boundary spine).

For every $q \geq 1$, let $\Gamma_4(q)$ be the graph described in Figure 20, and let us set $H_4(q) = H(\Gamma_4(q))$. It is obvious from the picture that $\Gamma_4(q)$ is a boundary spine of $H_4(q)$, so $H_4(q)$ is (3)_S-unknotted for every q . On the other hand, we have the following:

Proposition 5.17. *For every $q \geq 1$ we have*

$$\Phi_3(H_4(q)) = 3 + t^{2q}.$$

In particular, for every $q \geq 1$ the handlebody $H_4(q)$ is (2)_L-knotted. Moreover, if $q' \neq q$, then the handlebodies $H_4(q)$ and $H_4(q')$ are not isotopic.

Proof. As usual, the only (0,0)-colorings of $\Gamma_4(q)$ are the constant ones.

In order to describe the (1,0)-colorings of $\Gamma_4(q)$, let us first denote by $T(q)$ (resp. $B(q)$) the constituent knot of $\Gamma_4(q)$ which lies on the top (resp. on the bottom) of the picture. It is immediate to observe that $T(q)$ and $B(q)$ are both trivial. Let us now concentrate on (1,0)-colorings of $\Gamma_4(q)$, where we suppose for example that the cycle vanishes on $B(q)$. Under this assumption, it is immediate to realize that the (1,0)-colorings of $\Gamma_4(q)$ restrict to 1-colorings of $T(q)$. Since such knot is trivial, this implies that every (1,0)-coloring of $\Gamma_4(q)$ is constant on $T(q)$.

Together with the discussion in Subsection 5.9, this also implies that the colorings of $B(q)$ are not affected by the crossings between the bands of $B(q)$ and the bands of $T(q)$. Then, every (1,0)-coloring of $\Gamma_4(q)$ restricts to a 0-coloring (*i.e.* to a constant coloring) of $B(q)$.

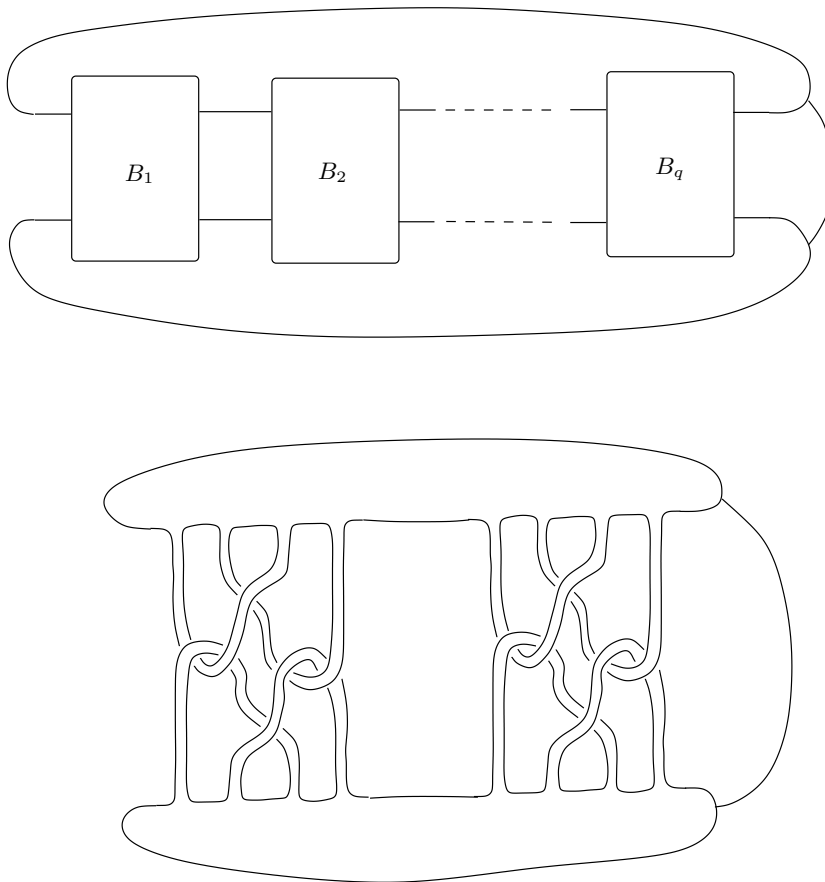

FIGURE 20. On the top: the spine $\Gamma_4(q)$. Every B_i is a copy of the tangle B . On the bottom: the case $q = 2$.

Since the (constant) colors of $T(q)$ and of $B(q)$ have to agree with the color of the isthmus, we can conclude that the only $(1,0)$ -colorings of $\Gamma_4(q)$ are the constant ones. The same is true (by the very same argument) also for $(0,1)$ -colorings, so we have already proved that $\Phi_3(H_4(q)) = 3 + t^\alpha$, where $3^{\alpha+1}$ is equal to the number of $(1,1)$ -colorings of $\Gamma_4(q)$.

Now, let us compute the number of $(1,1)$ -colorings of $\Gamma_4(q)$ that induce the color $a \in R_3$ on the isthmus. It is an immediate consequence of Lemma 5.17 that this number is equal to the q -times product of $C_3(a, a, a, a) = 3^2$. Since a can be chosen in 3 different ways, it readily follows that the number of $(1,1)$ -colorings of $\Gamma_4(q)$ is equal to 3^{2q+1} , so that

$$\Phi_3(H_4(q)) = 3 + t^{2q}.$$

By Lemma 5.7, we have that $H_4(q)$ is $(2)_L$ -knotted for every $q \geq 1$. Moreover, if $q \neq q'$ we have $\Phi_3(H_4(q)) \neq \Phi_3(H_4(q'))$, and this implies that $H_4(q)$ is not isotopic to $H_4(q')$. \square

6. HANDLEBODY PATTERNS AND THE MAXIMAL FREE COVERING

The main goal of this Section is to provide rather handy combinatorial/topological characterizations of the handlebody complements that admit a ∂ -connected (resp. ∂_R -connected) cut system. Following Jaco [26], we observe in Proposition 6.17 that the existence of a ∂ -connected or ∂_R -connected cut system for a handlebody complement M is related to the way in which $\pi_1(\partial M)$ sits inside $\pi_1(M)$. Then, in order to study the image of $\pi_1(\partial M)$ into

$\pi_1(M)$ we extend some techniques coming from the theory of homology boundary links to the context of spatial handlebodies.

After recalling the definition of link pattern, we define the analogous notion of *handlebody pattern*. In Proposition 6.20 we exploit this notion for constructing easily computable obstructions that allow to decide, starting from an explicitly given cut system for M , if M admits a ∂ -connected cut system. As an application, in Proposition 6.23 we provide a proof of the fact that the handlebodies $H_1(p)$ introduced in Subsection 5.6 are $(3)_S$ -knotted. For $p = 3$, this fact was already known to Lambert [30]. In our opinion, the characterization described in Proposition 6.20 is easier to handle in comparison, for instance, with the original Lambert's topological treatment of his example.

Building on Proposition 6.17, we also describe a group-theoretic obstruction for M to admit a ∂_R -connected cut system. This obstruction is then exploited in Proposition 6.24 for proving that there exist $(4)_L$ -unknotted handlebodies whose complement does not admit any ∂_R -connected cut system. As a consequence, the notions of $(4)_L$ -knotting and $(3)_L$ -knotting are not equivalent.

Jaco's obstruction for M to admit a ∂ -connected cut system admits a nice topological interpretation in terms of the *maximal free covering* \widetilde{M}_ω of M . At the end of the Section we introduce such a covering, and we prove that the boundary of \widetilde{M}_ω is connected if and only if M admits a ∂ -connected cut system. We also show that the study of the first homology groups of \widetilde{M}_ω and $\partial\widetilde{M}_\omega$ provides other obstructions for M to admit ∂ -connected (or ∂_R -connected) cut systems.

6.1. Cut systems and epimorphisms of the fundamental group. Let M be the complement in S^3 either of a genus-2 handlebody or of a 2-component link, set $G = \pi_1(M)$ and let $F_2 = F(t_1, t_2)$ be the free group on two generators t_1, t_2 . Recall that a necessary and sufficient condition for M to admit a cut system is that there exists an epimorphism $\varphi: \pi_1(M) \rightarrow F_2$. More precisely, if $\mathcal{S} = \{S_1, S_2\}$ is a cut system for M , then we can fix a basepoint $x_0 \in M \setminus \mathcal{S}$, and define an epimorphism $\varphi: G = \pi_1(M, x_0) \rightarrow F_2$ in such a way that, if $g \in G$ is represented by a loop disjoint from S_2 (resp. S_1) and intersecting positively S_1 (resp. S_2) in exactly one point, then $\varphi(g) = t_1$ (resp. $\varphi(g) = t_2$). We say that such a φ is *associated to \mathcal{S}* .

The following result is due to Stallings [44] and shows that, up to post-compositions with automorphisms of F_2 , there exists a unique epimorphism from G to F_2 . Define $G_1 = [G, G]$, $G_{n+1} = [G_n, G]$, $G_\omega = \bigcap_n G_n$.

Theorem 6.1 ([44]). *Suppose $G = \pi_1(M, x_0)$ is the fundamental group of M , and let $\varphi: G \rightarrow F_2$ be any epimorphism. Then $\ker \varphi = G_\omega$.*

Henceforth we tacitly make the assumption that every connected component of the boundary of a given cut system is *essential*, *i.e.* it does not bound a disk on ∂M . Of course, every cut system for M can be compressed in order to satisfy this requirement.

6.2. Link patterns. Keeping notations from Subsection 6.1, let us now specialize to the case when $M = C(L)$ is the complement of an (ordered and oriented) homology boundary link L .

As elements of G , the meridians of L are defined only up to conjugacy. For $i = 1, 2$, let $\gamma_i \in G$ be a representative of the i -th meridian of L , and set $w_i = \varphi(\gamma_i)$. Then w_i is well-defined up to conjugacy in F_2 . Adding to M two 2-handles along the meridians of L we obtain a space homeomorphic to $S^2 \times [0, 1]$, which is simply connected, so w_1, w_2 normally generate G (*i.e.* there do not exist proper normal subgroups of G containing w_1 and w_2).

Also recall that any epimorphism $\psi: G \rightarrow F_2$ is obtained from φ by post-composition with an automorphism of F_2 .

An old result by Nielsen (see *e.g.* [34] for a proof) ensures that every n -uple of generators of the free group F_n of rank n is in fact a set of free generators of F_n . Such an n -uple is called a *base* of F_n . The following definition is taken from [10].

Definition 6.2. A *link pattern* is a pair $(w_1, w_2) \in F_2 \times F_2$ such that w_1 and w_2 normally generate F_2 . The pattern (w_1, w_2) is realized by the link L if there exist an epimorphism $\varphi: \pi_1(\mathbb{C}(L)) \rightarrow F_2$ and a choice of meridians γ_1, γ_2 such that $\varphi(\gamma_i) = w_i$ for $i = 1, 2$. Two link patterns (w_1, w_2) and (w'_1, w'_2) are *equivalent* if there exist $h_1, h_2 \in F_2$ and $\alpha \in \text{Aut}(F_2)$ such that $w'_i = h_i \alpha(w_i) h_i^{-1}$. A pattern is *trivial* if it is equivalent to a base of F_2 .

The discussion above shows that to any homology boundary link there is associated a well-defined equivalence class of link patterns. Moreover, it is proved in [10] that every pattern is realized by a homology boundary link (see also [3] for an explicit construction).

Remark 6.3. Of course every two bases of F_2 are equivalent as link patterns, but if (t_1, t_2) is a base of F_2 , then the pair (t_1, wt_2w^{-1}) , while being trivial as a pattern, is not necessarily a base of F_2 . More precisely, let us show that (t_1, wt_2w^{-1}) is a base of F_2 if and only if $w = t_1^n t_2^m$ for some $m, n \in \mathbb{Z}$ (we will need this result later).

Of course, if $w = t_1^n t_2^m$, then t_1 and $wt_2w^{-1} = t_1^n t_2 t_1^{-n}$ generate the whole F_2 , so (t_1, wt_2w^{-1}) is a base of F_2 . On the other hand, let us suppose that (t_1, wt_2w^{-1}) is a base of F_2 , and let us choose $n \in \mathbb{Z}$ in such a way that $w' = t_1^{-n} w$ either is the identity, or is represented by a reduced word starting with the symbol t_2 or t_2^{-1} . Observe that $(t_1, w' t_2 (w')^{-1})$ is also a base of F_2 , so there exists an element $R(a, b)$ in the free group over two generators $F(a, b)$ such that $R(t_1, w' t_2 (w')^{-1}) = t_2$. Let now w'' be the reduced word representing $w' t_2 (w')^{-1}$. Then it is easily seen that in any product of the form $t_1^{\pm 1} (w'')^{\pm 1}$ there cannot be cancellations. It is easily seen that this forces $R(a, b) = b$, whence $w'' = t_2$, and $w' = t_2^m$ for some m . We have therefore $w = t_1^n t_2^m$, as claimed.

The following result, which was already observed by Smythe in [43], characterizes in terms of patterns those homology boundary links which are in fact boundary links.

Proposition 6.4. *A homology boundary link is a boundary link if and only if its associated link patterns are trivial.*

Recall that an element $w \in F_2$ is *primitive* if it is an element of a base of F_2 . There is an extensive literature about primitive elements in the free group on n generators, and a particular interest has been devoted to the case of rank two. The following Lemma provides an useful characterization of trivial link patterns:

Lemma 6.5. *Let $F(t_1, t_2) = F_2$ be the free group on two generators t_1, t_2 . Then:*

- (1) *A link pattern $(w_1, w_2) \in F_2 \times F_2$ is trivial if and only if w_1 and w_2 are both primitives.*
- (2) *Suppose that*

$$w = t_1^{\alpha_1} t_2^{\beta_1} t_1^{\alpha_2} t_2^{\beta_2} \dots t_1^{\alpha_m} t_2^{\beta_m}$$

is a cyclically reduced word representing a primitive element, where $\alpha_i \neq 0$, $\beta_i \neq 0$ for every $i = 1, \dots, m$. Then, all the α_i 's share the same sign, and all the β_i 's share the same sign.

Proof. Since (w_1, w_2) normally generate F_2 , they project onto a base of $F_2/[F_2, F_2] = \mathbb{Z}^2$. Therefore, point (1) follows from [20, page 167].

Point (2) dates back to Nielsen [35] (see *e.g.* [56], [13], [36] for alternative proofs). \square

6.3. Jaco's characterization of handlebody complements admitting ∂ -connected cut systems. Let us now consider the case when M is the complement of a spatial handlebody H such that $\text{cut}(M) = 2$. Let $\mathcal{S} = \{S_1, S_2\}$ be any cut system of M , and set $G = \pi_1(M, x_0)$, where x_0 is a basepoint such that $x_0 \in \partial M \setminus (S_1 \cup S_2)$. Let $F_2 = F(t_1, t_2)$ be the free group on two generators t_1, t_2 , and let $\varphi: G \rightarrow F_2$ be the epimorphism associated to \mathcal{S} .

Let us set $G_\partial = \pi_1(\partial M, x_0)$ and denote by $i: \partial M \rightarrow M$ the inclusion. The following result is proved in [26, Theorems 2 and 3], and in some sense extends Proposition 6.4 to the case of spatial handlebodies.

Proposition 6.6. *The manifold M admits a $(M \rightarrow W)$ -boundary-preserving-map (or, equivalently, a ∂ -connected cut system) if and only if $\varphi(i_*(G_\partial)) = F_2$, i.e. if and only if $i_*(G_\partial)$ surjectively projects onto G/G_ω .*

In what follows we show how Proposition 6.6 can be exploited for proving that the handlebodies $H_1(p)$ introduced in Subsection 5.6 are $(3)_S$ -knotted. Moreover, in Proposition 6.17 we extend Proposition 6.6 in order to obtain an obstruction for a handlebody complement to admit a ∂_R -connected cut system.

6.4. Cut systems and longitudes. Suppose that $X = \mathbb{C}(L)$ is the complement of a 2-component homology boundary link and let \mathcal{S} be a cut system for X . The boundary components of the surfaces of \mathcal{S} belong to two families of parallel curves, one on each component of ∂X . It is well-known that the isotopy classes of such curves on ∂X do not depend on the particular cut system \mathcal{S} (see also Subsection 6.14). These isotopy classes define the *longitudes* of L .

We would like to extend this notion to the case when $M = \mathbb{C}(H)$ is the complement of a handlebody H such that $\text{cut}(M) = 2$. It turns out that in this case the definition of longitudes is less obvious, and longitudes are in fact no more independent of the choice of a cut system (see Remark 7.5).

Lemma 6.7. *Let \mathcal{S} be a cut system for M . There exist three disjoint essential simple closed curves ℓ_1, ℓ_2, ℓ_3 on ∂M such that the following conditions hold:*

- (1) *each component of the reduced boundary of \mathcal{S} is parallel to ℓ_1, ℓ_2 or ℓ_3 ;*
- (2) *the union $\ell_1 \cup \ell_2$ is not separating in ∂M ;*
- (3) *ℓ_1 and ℓ_2 (provided with some orientations) give a basis of $\ker(i_*: H_1(\partial M) \rightarrow H_1(M))$;*
- (4) *if $\partial \mathcal{S} \setminus \partial_R \mathcal{S}$ is non-empty, then each component of the reduced boundary of \mathcal{S} is parallel to ℓ_1 or ℓ_2 , and each further component of $\partial \mathcal{S}$ is parallel to ℓ_3 .*

Proof. Since on ∂M there exist at most three non-parallel non-trivial unoriented simple loops, there exist three loops ℓ_1, ℓ_2, ℓ_3 such that every (unoriented) loop in $\partial \mathcal{S}$ is parallel to some ℓ_i , $i = 1, 2, 3$. Moreover, we may suppose that $\ell_1 \cup \ell_2$ does not separate ∂M , so that ℓ_1, ℓ_2, ℓ_3 may be oriented in such a way that either $[\ell_3] = [\ell_1] + [\ell_2]$ (if ℓ_3 does not separate ∂M) or $[\ell_3] = 0$ (if ℓ_3 separates ∂M). In any case the submodule of $H_1(\partial M)$ generated by the homology classes $[\partial S_1] \in H_1(\partial M)$ and $[\partial S_2] \in H_1(\partial M)$ is contained in $\langle [\ell_1], [\ell_2] \rangle$. It is proved for example in [1] that $\langle [\partial S_1], [\partial S_2] \rangle$ has rank 2, is equal to $\ker i_*$ and is not a proper finite-index submodule of any submodule of $H_1(\partial M)$. These facts easily imply (3), and (4) is obvious. \square

Definition 6.8. *Let \mathcal{S} , ℓ_1 and ℓ_2 be as in the statement of Lemma 6.7. Then we say that (the isotopy classes of) ℓ_1, ℓ_2 are a pair of longitudes associated to \mathcal{S} .*

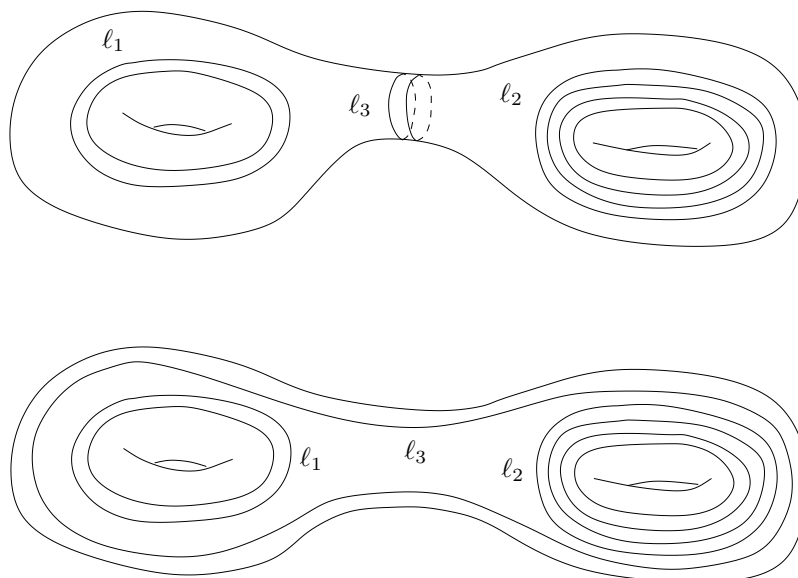

FIGURE 21. The boundary components of a cut system \mathcal{S} . On the top: l_3 separates ∂M , so \mathcal{S} is good. On the bottom: l_3 does not separate ∂M , and \mathcal{S} is not good.

If $\partial\mathcal{S} \setminus \partial_R\mathcal{S} \neq \emptyset$, then the longitudes of \mathcal{S} are uniquely determined by \mathcal{S} (see the top of Figure 21). On the contrary, if the connected components of $\partial\mathcal{S}$ are divided into three non-isotopic families of parallel curves each of which is non-separating, then \mathcal{S} defines three pairs of longitudes (see the bottom of Figure 21). In Lemma 6.10 we show how to get rid of this ambiguity, which anyway is not really relevant to our purposes.

Definition 6.9. We say that a cut system \mathcal{S} is *good* if the components of $\partial_R\mathcal{S}$ fall into two isotopy classes of curves on ∂M (and in this case such classes define the unique pair of longitudes associated to \mathcal{S}).

Lemma 6.10. *Let l_1, l_2 be a fixed pair of longitudes of the cut system \mathcal{S} . Then M admits a good cut system \mathcal{S}' with longitudes l_1, l_2 . If \mathcal{S} is ∂_R -connected, we may set $\mathcal{S}' = \mathcal{S}$.*

Proof. If every connected component of \mathcal{S} is parallel to l_1 or to l_2 , then we may set $\mathcal{S}' = \mathcal{S}$, and we are done. Otherwise, let l_3 be the loop defined in Lemma 6.7. If l_3 is separating (and this is the case, in particular, if \mathcal{S} is ∂_R -connected), then we may set $\mathcal{S}' = \mathcal{S}$. Otherwise, l_3 separates $\partial H \setminus (l_1 \cup l_2)$ in two pair of pants Y_1 and Y_2 with $\partial Y_1 = \partial Y_2 = l_1 \cup l_2 \cup l_3$. If $\partial\mathcal{S}$ has n components parallel to l_3 , we define \mathcal{S}' by replacing small neighbourhoods in \mathcal{S} of such components with n parallel copies of Y_1 (or of Y_2). \square

6.5. Handlebody patterns. Suppose now that \mathcal{S} is a good cut system for M , and fix an ordering and an auxiliary orientation on the longitudes l_1, l_2 of \mathcal{S} .

We now define three elements $w_0(\mathcal{S}), w_1(\mathcal{S}), w_2(\mathcal{S})$ of $F_2 = F(t_1, t_2)$ as follows. For $i = 1, 2$, let W_i be the non-annular component of $\partial M \setminus \partial\mathcal{S}$ whose closure contains (a loop isotopic to) l_i (if $\partial\mathcal{S} = \partial_R\mathcal{S}$, then $W_1 = W_2$ is homeomorphic to a 4-punctured sphere, otherwise both W_1 and W_2 are homeomorphic to 3-punctured spheres). Take basepoints $x_i \in W_i$, $i = 1, 2$, and recall that every component of $\partial\mathcal{S}$ inherits a well-defined orientation induced by the orientations of S_1, S_2 .

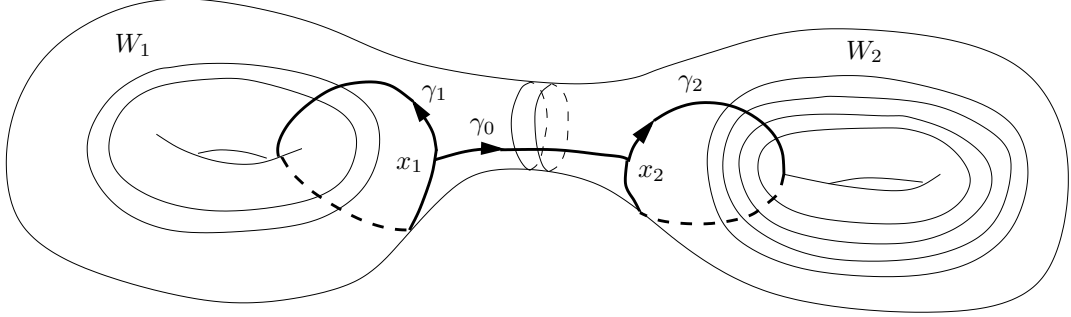

FIGURE 22. The definition of handlebody pattern.

For $i = 1, 2$ we fix a simple oriented loop γ_i on ∂M such that the following conditions hold (see Figure 22):

- γ_i is based at x_i and transverse to $\partial \mathcal{S}$;
- γ_i is disjoint from every separating connected component of \mathcal{S} ;
- γ_i is disjoint from every component of $\partial \mathcal{S}$ isotopic to ℓ_j for $j \neq i$;
- γ_i positively intersects a representative of ℓ_i exactly in one point;
- γ_i transversely intersects every component of $\partial \mathcal{S}$ isotopic to ℓ_i exactly in one point.

Starting and ending in x_1 , we now follow γ_1 and write down a letter t_i (resp. t_i^{-1}) every time γ_1 positively (resp. negatively) intersects a component of ∂S_i , thus obtaining a (not necessarily reduced) word $\tilde{w}_1(\mathcal{S})$ that represents the element $w_1(\mathcal{S}) \in F_2$. The word $\tilde{w}_2(\mathcal{S})$ and the element $w_2(\mathcal{S})$ are obtained by applying the very same procedure to γ_2 . Finally, we take an arc γ_0 starting at x_1 , ending at x_2 , and transversely intersecting each component of $\partial \mathcal{S} \setminus \partial_R \mathcal{S}$ exactly in one point, and we denote by $\tilde{w}_0(\mathcal{S})$ the word obtained by associating the element t_i (resp. t_i^{-1}) to every positive (resp. negative) intersection of γ_0 with ∂S_i . We also denote by $w_0(\mathcal{S})$ the element of F_2 associated to $\tilde{w}_0(\mathcal{S})$. Observe that $w_i(\mathcal{S})$ depends both on the orientations of S_1, S_2 (which is part of the datum \mathcal{S}), and on the fixed auxiliary orientations on ℓ_1, ℓ_2 . However, our notation forgets about this last dependence, since it is not relevant to our purposes.

Our next aim is to describe as explicitly as possible the relations between the topological properties of the cut system \mathcal{S} and the algebraic properties of the epimorphism φ associated to \mathcal{S} . These last properties are encoded by the $w_i(\mathcal{S})$'s, while the words $\tilde{w}_i(\mathcal{S})$'s keep track of the actual components of $\partial \mathcal{S}$. However, we will see in Lemma 6.14 below that the $w_i(\mathcal{S})$'s encode in some sense the “essential” information about $\partial \mathcal{S}$.

Let us now come back to the notation of Subsection 6.3, suppose that \mathcal{S} is good, and set $x_0 = x_1$, i.e. let $G = \pi_1(M, x_1)$ and $G_\partial = \pi_1(\partial M, x_1)$.

Lemma 6.11. *Let $w_0(\mathcal{S}), w_1(\mathcal{S}), w_2(\mathcal{S})$ be as above. Then:*

- (1) $\varphi(i_*(G_\partial)) \subseteq F_2$ is generated by the elements $w_1(\mathcal{S})$ and $w_0(\mathcal{S})w_2(\mathcal{S})w_0(\mathcal{S})^{-1}$.
- (2) The pair $(w_1(\mathcal{S}), w_2(\mathcal{S}))$ normally generates F_2 .
- (3) The kernel of the map $\varphi \circ i_*: G_\partial \rightarrow F_2$ is normally generated by any pair of loops which are freely homotopic to the longitudes of \mathcal{S} .

Proof. (1): For $i = 1, 2$, let $l_i \subseteq \partial M$ be a loop based at x_i which is isotopic to ℓ_i and disjoint from $\partial \mathcal{S}$. Then, the group G_∂ is generated by the elements

$$g_1 = [\gamma_1], \quad g_2 = [\gamma_0 * \gamma_2 * \gamma_0^{-1}], \quad n_1 = [l_1], \quad n_2 = [\gamma_0 * l_2 * \gamma_0^{-1}].$$

Since φ is associated to \mathcal{S} , we have

$$(3) \quad \varphi(i_*(g_1)) = w_1(\mathcal{S}), \quad \varphi(i_*(g_2)) = w_0(\mathcal{S})w_2(\mathcal{S})w_0(\mathcal{S})^{-1}, \quad \varphi(i_*(n_1)) = \varphi(i_*(n_2)) = 1,$$

whence point (1).

(2): By point (1), it is sufficient to prove that $i_*(G_\partial)$ normally generates G . Let m_1, m_2 be simple closed loops of ∂M which bound disjoint compressing disks D_1, D_2 in the handlebody H in such a way that $D_1 \cup D_2$ does not separate H . The smallest normal subgroup N of G containing $i_*(G_\partial)$ also contains the (conjugacy classes of) two elements h_1, h_2 which are freely homotopic to m_1 and m_2 in ∂M . But the fundamental group of $M \cup D_1 \cup D_2$ is obviously trivial, so an easy application of Seifert–Van Kampen Theorem implies that the smallest normal subgroup of G containing h_1, h_2 coincides with G . We have *a fortiori* $N = G$, whence point (2).

(3): Take $g \in G_\partial$, and let g_1, g_2, n_1, n_2 be the generators of G_∂ introduced in the proof of point (1). There exists a word $R(a, b, c, d)$ in the symbols $a^{\pm 1}, b^{\pm 1}, c^{\pm 1}, d^{\pm 1}$ such that $g = R(g_1, g_2, n_1, n_2)$. Since $\varphi(i_*(n_i)) = 1$ for $i = 1, 2$, the element $\varphi(i_*(g)) \in F_2$ is represented by the word $\overline{R}(\varphi(i_*(g_1)), \varphi(i_*(g_2)))$, where $\overline{R}(a, b) = R(a, b, \emptyset, \emptyset)$ is obtained from R by replacing each occurrence of $c^{\pm 1}$ and $d^{\pm 1}$ with the empty word.

It follows from point (2) that the elements $\varphi(i_*(g_1)), \varphi(i_*(g_2))$ freely generate a rank-2 subgroup of F_2 . This implies in turn that $\varphi(i_*(g)) = 1$ if and only if the word \overline{R} represents the trivial element of $F(a, b)$. This last condition is in turn equivalent to the fact that g belongs to the subgroup of G_∂ normally generated by n_1, n_2 , whence the conclusion. \square

We are now ready to define the notion of handlebody pattern.

Definition 6.12. A *handlebody pattern* is a triple $(w_0, w_1, w_2) \in F_2 \times F_2 \times F_2$ such that w_1, w_2 normally generate F_2 (i.e. (w_1, w_2) is a link pattern). If M, \mathcal{S} and ℓ_1, ℓ_2 are as above, then we say that $(w_0(\mathcal{S}), w_1(\mathcal{S}), w_2(\mathcal{S}))$ is the pattern associated to \mathcal{S} . We also say that $(w_0(\mathcal{S}), w_1(\mathcal{S}), w_2(\mathcal{S}))$ is realized by M (or by H).

A pattern (w_0, w_1, w_2) is *trivial* if the pair $(w_1, w_0w_2w_0^{-1})$ is a base of F_2 (by Remark 6.3, this condition is strictly stronger than the condition that (w_1, w_2) is trivial as a link pattern).

Remark 6.13. With some effort it is possible to define an equivalence relation on the set of handlebody patterns, in such a way that a fixed M uniquely defines an equivalence class of handlebody patterns. Such equivalence relation is a bit more complicated than the one defined on link patterns, and since we won't need to exploit the notion of equivalent handlebody patterns, we are not discussing it here (however, it is maybe worth mentioning that Lemma 6.14 below shows for example that, with respect to this relation, the handlebody pattern (w_0, w_1, w_2) should be equivalent to $(1, w_1, w_0w_2w_0^{-1})$).

Moreover, putting together Lemma 6.19 with the fact that every link pattern is realized by a homology boundary link it can be easily proved that every handlebody pattern is realized by a spatial handlebody.

The following Lemma shows that patterns encode the relevant information about the topology of the boundary of cut systems.

Lemma 6.14. *Let \mathcal{S} be a good cut system for M and let g_1, g_2 be elements in F_2 . Then M admits a good cut system \mathcal{S}' satisfying the following conditions:*

- (1) \mathcal{S}' has the same longitudes as \mathcal{S} .
- (2) $(w_0(\mathcal{S}'), w_1(\mathcal{S}'), w_2(\mathcal{S}')) = (g_1w_0(\mathcal{S})g_2^{-1}, g_1w_1(\mathcal{S})g_1^{-1}, g_2w_2(\mathcal{S})g_2^{-1})$.
- (3) for $i = 1, 2, 3$, the word $\tilde{w}_i(\mathcal{S}')$ is reduced (if $w_0(\mathcal{S}') = 1$, then it is understood that $\tilde{w}_0(\mathcal{S}')$ is the empty word, i.e. that $\partial\mathcal{S} = \partial_R\mathcal{S}$).

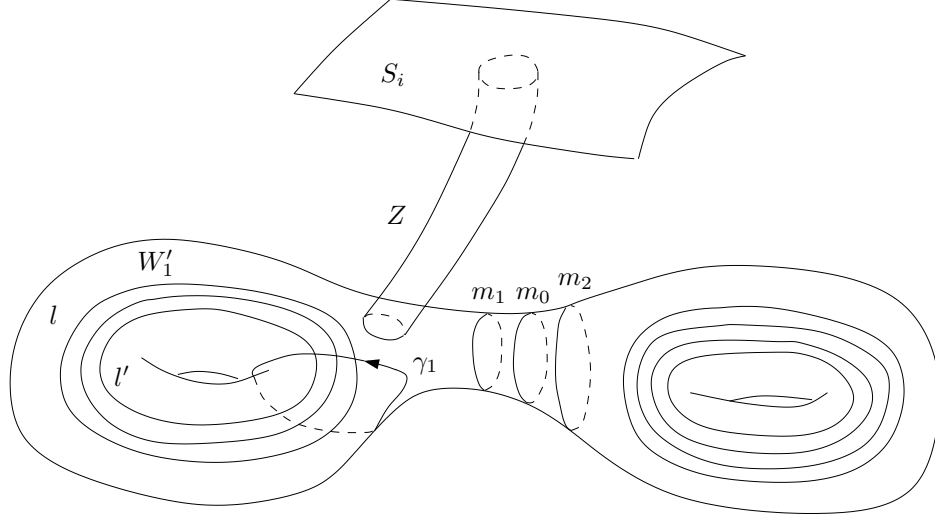

FIGURE 23. The construction described in the proof of Lemma 6.14.

Proof. Let ℓ_1, ℓ_2 be the longitudes of $\mathcal{S} = \{S_1, S_2\}$, and let us denote by m_1, \dots, m_l the components of $\partial\mathcal{S} \setminus \partial_R\mathcal{S}$, and by W_1 (resp. W_2) the non-annular component of $\partial M \setminus \partial\mathcal{S}$ whose boundary contains a loop isotopic to ℓ_1 (resp. ℓ_2). If $l \geq 1$, we order the m_i 's in such a way that m_1 (resp. m_l) is a boundary component of W_1 (resp. W_2), and m_i, m_{i+1} bound an annulus in $\partial M \setminus \partial\mathcal{S}$ for $i = 1, \dots, m-1$.

Let us first consider the case when $g_1 = t_i^{\pm 1}$ and $g_2 = 1$. Let us fix an embedded arc $\alpha: [0, 1] \rightarrow M$ satisfying the following properties: $\alpha(0) \in S_i$, $\alpha(1) \in W_1$ and $\alpha(t) \in M \setminus (\partial M \cup S_1 \cup S_2)$ for every $t \in (0, 1)$ (such an arc exists because $M \setminus (S_1 \cup S_2)$ is connected). Let $Z = D^2 \times [0, 1] \subseteq M$ be a 1-handle satisfying the following conditions (see Figure 23):

- α is the core of Z ;
- $Z \cap (S_1 \cup S_2) = Z \cap S_1 = D^2 \times \{0\}$ is a regular neighbourhood of $\alpha(0)$ in $S_i \setminus \partial S_i$;
- $Z \cap \partial M = Z \times \{1\}$ is a regular neighbourhood of $\alpha(1)$ in $W_1 \setminus \partial W_1$.

Let now γ_0 and γ_1 be the loop and the arc of ∂M entering in the definition of the handlebody pattern associated to \mathcal{S} . Let $m_0 \subseteq W_1$ be a simple loop parallel to m_1 which is disjoint from γ_1 and transversely intersects γ_0 exactly in one point, and let $l, l' \subseteq W_1$ be two loops isotopic to the components of $\partial W_1 \setminus m_1$. We also assume that γ_1 transversely meets l and l' exactly in one point and in this order. Finally, we denote by $W'_1 \subseteq W_1$ the pair of pants bounded by m_0, l, l' . Up to shrinking Z , we may suppose that $D^2 \times \{0, 1\}$ is contained in the internal part of W'_1 . Let now S'_i be defined by

$$S'_1 = (S_1 \cup (\partial D^2 \times [0, 1]) \cup W'_1) \setminus (\text{int}(D^2) \times \{0, 1\}) ,$$

and endow S'_i with the orientation induced by S_i . It is clear that we may push $\text{int}(S'_i) \cap \partial M$ slightly inside M thus obtaining a new cut system $\mathcal{S}' = \{S'_i, S_j\}$ for M . By construction, as a set we have that $\partial\mathcal{S}'$ is obtained from \mathcal{S} by adding m_0, l and l' . It is easily seen that if γ_0 intersects m_0 positively (resp. negatively), then γ_1 intersects l positively (resp. negatively) and l' negatively (resp. positively). Therefore, we get

$$w_0(\mathcal{S}') = t_i^{\pm 1} w_0(\mathcal{S}), \quad w_1(\mathcal{S}') = t_i^{\pm 1} w_1(\mathcal{S}) t_i^{\mp 1}, \quad w_2(\mathcal{S}') = w_2(\mathcal{S}) .$$

In order to get the desired exponent for the added factors $t_i^{\pm 1}$, it is sufficient to replace α , if necessary, with an arc enjoying the very same properties as α , but exiting from S_i on the opposite side with respect to α .

The very same proof also shows how \mathcal{S} can be modified in order to obtain a cut system \mathcal{S}' such that

$$w_0(\mathcal{S}') = w_0(\mathcal{S})t_i^{\pm 1}, \quad w_1(\mathcal{S}') = w_1(\mathcal{S}), \quad w_2(\mathcal{S}') = t_i^{\mp 1}w_2(\mathcal{S})t_i^{\pm 1}.$$

After repeating the construction just described a finite number of times, we obtain a cut system \mathcal{S}' satisfying conditions (1) and (2).

In order to conclude, it is now sufficient to show that we may replace \mathcal{S}' with a cut system having the same longitudes and the same pattern, and satisfying the additional property that its associated words are all reduced. So, let us suppose that a string of the form $t_j^{\pm 1}t_j^{\mp 1}$ appears in $\tilde{w}_i(\mathcal{S}')$ for some $i = 0, 1, 2$. Then, the components c, c' of $\partial\mathcal{S}'$ corresponding to the symbols $t_j^{\pm 1}, t_j^{\mp 1}$ belong to the same surface S_j of \mathcal{S} , bound an annulus A in $\partial M \setminus \partial\mathcal{S}$, and inherit from S_j opposite orientations. This implies that the surface \widehat{S}_j obtained by cutting from S_j small neighbourhoods of c and c' and adding the annulus A' obtained by pushing A slightly inside M is orientable, and may be given, therefore, the orientation induced by S_j . Moreover, \widehat{S}_j is obviously disjoint from S_2 , so we may modify \mathcal{S}' by replacing S_j with \widehat{S}_j . This operation has the effect of cancelling out the string $t_j^{\pm 1}t_j^{\mp 1}$ from $\tilde{w}_i(\mathcal{S}')$. After a finite number of operations of this type we end up with a cut system satisfying all the properties of the statement. \square

For later purposes we point out the following easy Corollary of the previous Lemma:

Corollary 6.15. *Let \mathcal{S} be a good cut system for M . Then M admits a good cut system \mathcal{S}' having the same longitudes as \mathcal{S} and satisfying the additional property that $\partial\mathcal{S} = \partial_R\mathcal{S}$.*

Proof. It is sufficient to apply Lemma 6.14 to the case $g_1 = w_0(\mathcal{S})^{-1}, g_2 = 1$. \square

6.6. $(4)_L$ -knotting is equivalent to $(4)_S$ -knotting. As an application of Lemma 6.14 we obtain the following:

Proposition 6.16. *A spatial handlebody H is $(4)_L$ -knotted if and only if it is $(4)_S$ -knotted.*

Proof. Let us prove that if H is $(4)_L$ -unknotted, then it is $(4)_S$ -unknotted, the other implication being trivial. So, let Γ be a spine of H such that the link L_Γ is homology boundary, and let S_1, S_2 be a pair of generalized Seifert surfaces for L_Γ . We may suppose that S_i is transverse to the isthmus of Γ for $i = 1, 2$. Then, up to shrinking H onto a smaller neighbourhood of Γ , the surfaces $S_1 \cap M, S_2 \cap M$ define a good cut system \mathcal{S} for M such that the components of $\partial\mathcal{S} \setminus \partial_R\mathcal{S}$ bijectively correspond to the points where $S_1 \cup S_2$ intersects the isthmus of Γ .

By Corollary 6.15, we may replace \mathcal{S} with a cut system \mathcal{S}' having the same longitudes as \mathcal{S} and such that $\partial\mathcal{S} = \partial_R\mathcal{S}$. Now it is not difficult to realize that one can add some annuli to \mathcal{S}' in order to obtain a pair of disjoint generalized Seifert surfaces for L_Γ whose interiors do not intersect the isthmus of Γ . \square

6.7. Patterns and obstructions. We are now ready to exploit patterns in order to decide about the existence of ∂ -connected or ∂_R -connected cut systems for M .

Proposition 6.17. *Suppose \mathcal{S} is any good cut system for M with associated pattern (w_0, w_1, w_2) . Then:*

- (1) M admits a ∂ -connected cut system if and only if (w_0, w_1, w_2) is trivial;

- (2) if M admits a ∂_R -connected cut system, then there exists a trivial link pattern whose elements are contained in the subgroup of F_2 generated by w_1 and $w_0w_2w_0^{-1}$.

Proof. Point (1) is an immediate consequence of Proposition 6.6 and Lemma 6.11, so we only have to prove point (2).

By the very definition of associated pattern, if \mathcal{S}' is a ∂_R -connected cut system for M , then, up to suitably choosing the ordering and the orientations of the longitudes of \mathcal{S}' , we may assume that $w_1(\mathcal{S}') = t_1$, $w_2(\mathcal{S}') = t_2$. By Lemma 6.11 (applied with respect to \mathcal{S}'), this implies that $\varphi(i_*(G_\partial))$ contains the link pattern $(t_1, w_0(\mathcal{S}')t_2w_0(\mathcal{S}')^{-1})$, which is obviously trivial. But by Lemma 6.11 again (now applied to the cut system \mathcal{S}), the group $\varphi(i_*(G_\partial))$ is generated by w_1 and $w_0w_2w_0^{-1}$, whence the conclusion. \square

6.8. Patterns of $(4)_L$ -unknotted handlebodies. Let H be a $(4)_L$ -unknotted spatial handlebody and let $\Gamma \in \mathcal{S}(H)$ be a spine of H such that $L_\Gamma = K_1 \cup K_2$ is a homology boundary link. Also denote by S_1, S_2 a pair of disjoint generalized Seifert surfaces for the knots K_1, K_2 , and by α the isthmus of Γ . Up to isotopy, we may suppose that α transversely intersects $S_1 \cup S_2$ in a finite number of points x_1, \dots, x_l . Moreover, we may order x_1, \dots, x_l in such a way that they appear consecutively along α when running from K_1 to K_2 , and label each x_i with the letter t_j (resp. t_j^{-1}) if x_i belongs to S_j and α intersects S_j at x_i positively (resp. negatively). We define the element

$$\mathcal{I}(S_1, S_2, \Gamma) \in F_2$$

as the product of the labels of x_1, \dots, x_l .

Up to isotopy, we may assume that H transversely intersects $S_1 \cup S_2$ in some annuli (each of which has one boundary component on $K_1 \cup K_2$) and in a collection of meridian disks that separate H and bijectively correspond to the points of intersection between α and $S_1 \cup S_2$. Let us set $\mathcal{S} = \{S_1 \cap M, S_2 \cap M\}$, where as usual $M = \mathbb{C}(H)$, and fix on $S_i \cap M$ the orientation induced by S_i .

The following Lemma is an immediate consequence of our definitions:

Lemma 6.18. *We have*

$$w_0(\mathcal{S}) = \mathcal{I}(S_1, S_2, \Gamma) .$$

Lemma 6.19. *Let L be a homology boundary link, and suppose that (w_1, w_2) is a pattern realized by L . Then, for every $w_0 \in F_2$ there exists a spatial handlebody H having L as constituent link and realizing the pattern (w_0, w_1, w_2) .*

Proof. Let us set $X = \mathbb{C}(L)$, and denote by K_1 and K_2 the knots such that $L = K_1 \cup K_2$. By the very definition of associated pattern, we may choose disjoint generalized Seifert surfaces S_1, S_2 for K_1, K_2 , a basepoint $x_0 \in X \setminus (S_1 \cup S_2)$, and two elements $m_1, m_2 \in \pi_1(X, x_0)$ representing the meridians of K_1, K_2 in such a way that $\varphi(m_1) = w_1$, $\varphi(m_2) = w_2$, where $\varphi: \pi_1(X, x_0) \rightarrow F_2$ is the epimorphism associated to $S_1 \cup S_2$.

Let us denote by $\partial_i X$ the component of ∂X corresponding to K_i , and choose a basepoint $x_i \in \partial_i X \setminus (\partial S_1 \cup \partial S_2)$. For $i = 1, 2$, let $\overline{m}_i \subseteq \partial_i X$ be a simple loop based at x_i and representing a meridian of K_i , and choose a simple arc $\alpha_i \subseteq X \setminus (S_1 \cup S_2)$ joining x_0 to x_i . Let $m'_i \in \pi_1(X, x_0)$ be the element represented by the loop $\alpha_i * \overline{m}_i * \alpha_i^{-1}$. Then there exists $h_i \in F_2$ such that $\varphi(m'_i) = h_i \varphi(m_i) h_i^{-1} = h_i w_i h_i^{-1}$.

Let now β be the (homotopy class of a) loop in $\pi_1(X, x_0)$ such that $\varphi(\beta) = h_1 w_0 h_2^{-1}$ and let $\alpha' = \alpha_1^{-1} * \beta * \alpha_2$. Let also $\alpha \subseteq X$ be a simple arc satisfying the following properties: it is properly embedded in X with endpoints x_1, x_2 ; it is homotopic in X relative to its endpoints to the arc α' ; it transversely intersects $S_1 \cup S_2$ in a finite number of points. Finally, let us

set $\Gamma = K_1 \cup K_2 \cup \alpha$, $H = N(\Gamma)$ and $M = \mathbf{C}(H)$. Also denote by $\mathcal{S} = \{S_1 \cap M, S_2 \cap M\}$ the cut system of M obtained as above from $S_1 \cup S_2$.

Our construction now implies that

$$w_0(\mathcal{S}) = \mathcal{I}(S_1, S_2, \Gamma) = h_1 w_0 h_2^{-1}, \quad w_1(\mathcal{S}) = \varphi(m'_1) = h_1 w_1 h_1^{-1}, \quad w_2(\mathcal{S}) = \varphi(m'_2) = h_2 w_2 h_2^{-1}.$$

Lemma 6.14 now implies that M admits a cut system \mathcal{S}' such that $w_i(\mathcal{S}') = w_i$ for $i = 0, 1, 2$, whence the conclusion. \square

6.9. Patterns of $(3)_L$ -unknotted handlebodies. Building on Proposition 6.17 we are now able to describe an effective algorithm which decides if a $(3)_L$ -unknotted handlebody admits a $(M \rightarrow W)$ -boundary-preserving-map (or, equivalently, a ∂ -connected cut system).

Proposition 6.20. *Let H be a $(3)_L$ -unknotted spatial handlebody and let Γ be a spine of H such that $L_\Gamma = K_1 \cup K_2$ is a boundary link with Seifert surfaces S_1, S_2 . We also set as usual $M = \mathbf{C}(H)$. Then:*

- (1) *If $\mathcal{I}(S_1, S_2, \Gamma) = t_1^n t_2^m$ for some $n, m \in \mathbb{Z}$, then Γ is a boundary spine for H . In particular, H is $(3)_S$ -unknotted and M admits a ∂ -connected cut system.*
- (2) *Otherwise, M does not admit any ∂ -connected cut system. In particular, H is $(3)_S$ -knotted.*

Proof. Let \mathcal{S} be the cut system of M obtained from $S_1 \cup S_2$ as described above, and let ℓ_1, ℓ_2 be the longitudes of \mathcal{S} , oriented in such a way that $\ell_i \subseteq \partial S_i$ inherits the orientation induced by S_i . By Lemma 6.18, the manifold M realizes the pattern $(\mathcal{I}(S_1, S_2, \Gamma), t_1, t_2)$.

Let us now suppose that M admits a ∂ -connected cut system. By Proposition 6.17 we have that $(\mathcal{I}(S_1, S_2, \Gamma), t_1, t_2)$ is trivial, and by Remark 6.3 this implies in turn that $\mathcal{I}(S_1, S_2, \Gamma) = t_1^n t_2^m$ for some $n, m \in \mathbb{Z}$. We have thus proved point (2).

In order to conclude, it is sufficient to show that if $\mathcal{I}(S_1, S_2, \Gamma) = t_1^n t_2^m$ for some $n, m \in \mathbb{Z}$, then Γ is a boundary spine for H .

In fact, under the assumption $\mathcal{I}(S_1, S_2, \Gamma) = t_1^n t_2^m$ we will show that Lemma 6.14 provides an explicit procedure which replaces S_1, S_2 with a pair of Seifert surfaces for K_1, K_2 whose internal parts are disjoint from the isthmus α of Γ .

As mentioned above, we have $w_0(\mathcal{S}) = \mathcal{I}(S_1, S_2, \Gamma) = t_1^n t_2^m$, $w_1(\mathcal{S}) = t_1$, $w_2(\mathcal{S}) = t_2$. We may now apply Lemma 6.14 to the case $g_1 = t_1^{-n}$, $g_2 = t_2^{-m}$, thus obtaining a cut system $\mathcal{S}' = \{S'_1, S'_2\}$ such that $\tilde{w}_1(\mathcal{S}') = t_1$, $\tilde{w}_2(\mathcal{S}') = t_2$ and $\tilde{w}_0(\mathcal{S}')$ is the empty word. It follows that \mathcal{S}' is ∂ -connected. Moreover, since the longitudes ℓ_1, ℓ_2 of \mathcal{S}' coincide with those of \mathcal{S} , we may obtain the desired Seifert surfaces for K_1 and K_2 just by adding to S'_i an annulus $A_i \subseteq H$ bounded by $K_i \cup \ell_i$ for $i = 1, 2$. \square

The following results are immediate consequences of Proposition 6.20. By Theorem 3.11 proved in Section 7 below, in Corollary 6.21 the hypothesis that H is $(3)_L$ -unknotted is superfluous. Note however that the proof of Theorem 3.11 relies on very deep results, such as the genus-2 Poincaré conjecture (see Remark 7.4).

Corollary 6.21. *Suppose H is a $(3)_L$ -unknotted spatial handlebody. Then, H is $(3)_S$ -knotted if and only if $M = \mathbf{C}(H)$ does not admit any ∂ -connected cut system.*

Corollary 6.22. *Suppose H is a $(3)_S$ -unknotted spatial handlebody, and let $\Gamma \in \mathcal{S}(H)$ be a spine of H such that L_Γ is a boundary link. Then, Γ is a boundary spine of H .*

6.10. $(1)_L$ -knotting does not imply $(3)_S$ -knotting. Let us come back to the examples described in Subsection 5.6 (see Figure 12) and in Subsection 5.11 (see Figure 17).

The constituent link L of the spine $\Gamma_1(p)$ is trivial, and it admits an obvious pair of disjoint Seifert surfaces S_1, S_2 given by the disks bounded by the components of L and lying on the blackboard plane. It is readily seen that we may choose orientations in such a way that

$$\mathcal{I}(S_1, S_2, \Gamma_1(p)) = t_1(t_2 t_1)^{\frac{p-1}{2}} t_2 .$$

In a similar way, the isthmus of $\Gamma_3(p)$ intersects the union of the obvious Seifert surfaces of $L_{\Gamma_3(p)}$ in such a way that

$$\mathcal{I}(S_1, S_2, \Gamma_3(p)) = t_1(t_2 t_1)^{\frac{p-1}{2}} t_2 .$$

Therefore, the criterion described in Proposition 6.20 immediately implies the following:

Proposition 6.23. *For every odd prime p , the manifolds $M_1(p)$ and $M_3(p)$ introduced in Subsections 5.6 and 5.11 do not admit any ∂ -connected cut system. In particular, the handlebodies $H_1(p)$ and $H_3(p)$ are $(3)_S$ -knotted. Since $H_1(p)$ is clearly $(1)_L$ -unknotted, it follows that $(3)_S$ -knotting does not imply $(1)_L$ -knotting.*

We give a different proof of the fact that $H_1(p)$ is $(3)_S$ -knotted in Proposition 8.18.

6.11. **$(3)_L$ -knotting does not imply $(4)_L$ -knotting.** In this Subsection we exploit Proposition 6.17 for constructing examples of $(4)_L$ -unknotted handlebodies which do not admit any constituent boundary link. More precisely, we prove the following:

Proposition 6.24. *Let L be a homology boundary link which is not a boundary link. Then, L is a constituent link of a handlebody H whose complement $M = \mathbf{C}(H)$ does not admit any ∂_R -connected cut system. In particular:*

- (1) H is $(3)_L$ -knotted and $(4)_L$ -unknotted.
- (2) M admits a cut system, but does not admit any ∂_R -connected cut system.

Proof. Let (w_1, w_2) be a pattern realized by L . Recall that w_1 and w_2 project onto a basis of $F_2/[F_2, F_2]$, so if we had $w_1 = t_1^k$ and $w_2 = t_2^h$ for some $h, k \in \mathbb{Z}$, then we would get $k = \pm 1$, $h = \pm 1$, and (w_1, w_2) would be trivial as a link pattern, against our assumption that L is not a boundary link. Let us assume that $w_1 \neq t_1^{\pm h}$, the case when $w_2 \neq t_2^{\pm h}$ being similar. Then there exists $n \in \mathbb{N}$ such that the following conditions hold:

- (1) the reduced word representing $t_1^n w_1 t_1^{-n}$ is given by $t_1^{k_1} z_1 t_1^{-h_1}$, where $h_1 \geq 1$, $k_1 \geq 1$ (so z_1 is not empty, and contains the symbol $t_2^{\pm 1}$);
- (2) the reduced word representing $t_2^n w_2 t_2^{-n}$ is either equal to $t_2^{l_2}$ for some $l_2 \in \mathbb{Z}$, or to $t_2^{k_2} z_2 t_2^{-h_2}$, where $h_2 \geq 1$, $k_2 \geq 1$ (and in this case z_2 is not empty, and contains the symbol $t_1^{\pm 1}$).

By Lemma 6.19, there exists a handlebody H with constituent link L and associated pattern $(t_1^{-n} t_2^n, w_1, w_2)$. Let us set $w'_1 = t_1^n w_1 t_1^{-n}$, $w'_2 = t_2^n w_2 t_2^{-n}$. By Lemma 6.14, the handlebody H also realizes the pattern $(1, w'_1, w'_2)$. Let us set $M = \mathbf{C}(H)$. By Proposition 6.17–(2), in order to conclude it is sufficient to show that there does not exist a trivial link pattern whose elements are contained in the subgroup J of F_2 generated by w'_1 and w'_2 .

We first look at which elements of J can be primitive in $F(t_1, t_2)$. So, let us take a non-trivial element $R \in F(a, b)$ such that $R(w'_1, w'_2)$ is primitive in $F(t_1, t_2)$. Let R' be a cyclically reduced conjugate of R , and observe that $R'(w'_1, w'_2)$ is also primitive. Let us first assume that both a and b appear in R' (*i.e.* that R' is not of the form $R' = a^h$ or $R' = b^h$ for some $h \in \mathbb{Z}$). Then, points (1) and (2) above easily imply that the reduced word representing $R'(w'_1, w'_2)$ is cyclically reduced, and contains the symbol t_1 both with positive and with negative exponents. The criterion described in Lemma 6.5–(2) now implies that $R'(w'_1, w'_2)$ cannot be primitive in F_2 .

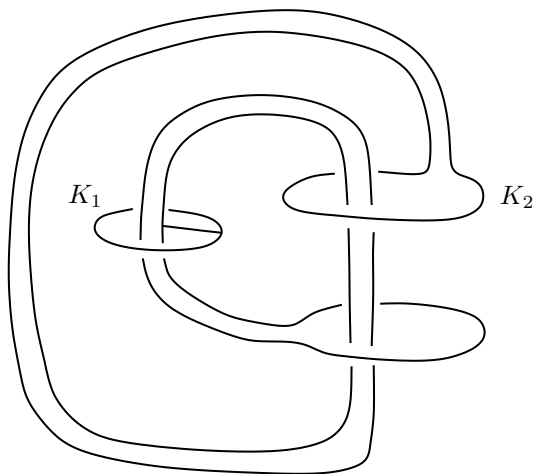

FIGURE 24. The spine of a $(4)_L$ -unknotted handlebody which is $(3)_L$ -knotted.

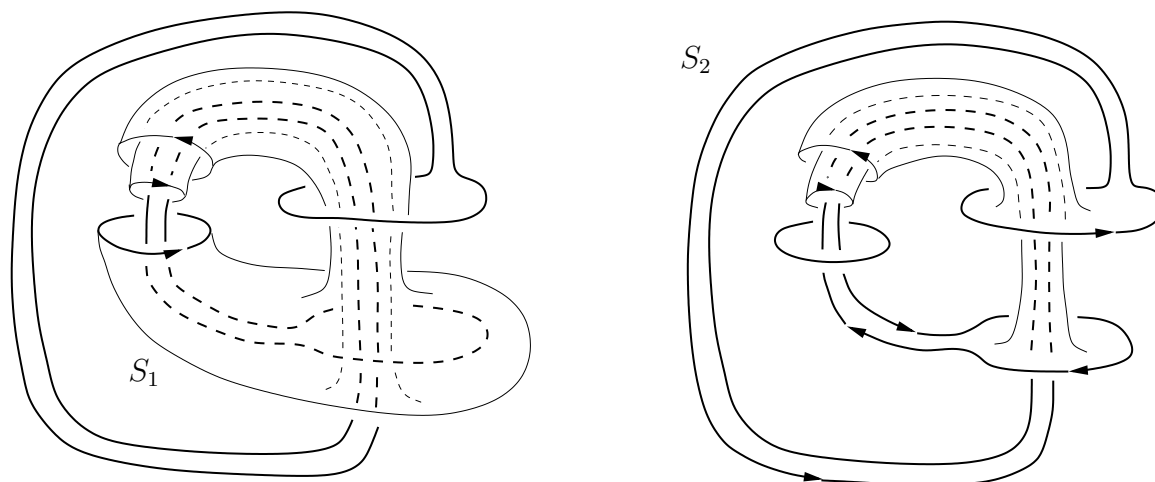

FIGURE 25. The generalized Seifert surfaces S_1 and S_2 . In order to get a clearer picture, for $i = 1, 2$ we have cut from S_i small annular neighbourhoods of two components of ∂S_i .

Therefore, if $R(w'_1, w'_2)$ is primitive, then we have either $R'(w'_1, w'_2) = t_1^n w_1^h t_1^{-n}$ or $R'(w'_1, w'_2) = t_2^n w_2^h t_2^{-n}$ for some $h \in \mathbb{Z}$. Since primitives of F_2 project onto indivisible elements of $F_2/[F_2, F_2]$, this forces $h = \pm 1$. Since $R(w'_1, w'_2)$ is conjugate (in J) to $R'(w'_1, w'_2)$, we may conclude that every element of J which is primitive in F_2 is conjugated (in F_2) either to $w_1^{\pm 1}$ or to $w_2^{\pm 1}$. Since the elements of a pattern project onto a base of $F_2/[F_2, F_2]$, this implies that if (z_1, z_2) is a link pattern whose elements are contained in J , then (z_1, z_2) is equivalent to $(w_1^{\pm 1}, w_2^{\pm 1})$. Since L is not a boundary link, the pattern $(w_1^{\pm 1}, w_2^{\pm 1})$ is not trivial, and this implies in turn that (z_1, z_2) is not trivial. We have eventually showed that there does not exist any trivial link pattern whose elements are contained in J , and this concludes the proof of the Proposition. \square

6.12. An example. We now describe an explicit example of a $(3)_L$ -knotted handlebody admitting a constituent homology boundary link.

Let Γ be the spine described in Figure 24, and set $H = H(\Gamma)$, $M = \mathbf{C}(H)$. The constituent link $L_\Gamma = K_1 \cup K_2$ was introduced by Cochran and Orr in [11, 12] and provides the first example of a homology boundary link which is not concordant to a boundary link (in particular, it is not a boundary link). Following [2, Diagram 1.4], in Figure 25 we have drawn a pair S_1, S_2 of generalized Seifert surfaces for $K_1 \cup K_2$. The three boundary components of S_1 all lie on K_1 (and exactly two of them have the same orientation as K_1), while S_2 has one boundary component on K_2 and two boundary components (having opposite orientations) on K_1 .

Let us denote by $\mathcal{S} = \{S_1 \cap M, S_2 \cap M\}$ the cut system of M defined by S_1 and S_2 (see Subsection 6.8). Up to isotopy, we may suppose that the isthmus of Γ is disjoint from $\text{int}(S_1) \cup \text{int}(S_2)$. It is now an easy exercise to show that

$$w_0(\mathcal{S}) = \mathcal{I}(S_1, S_2, \Gamma) = 1, \quad w_1(\mathcal{S}) = t_1 t_2 t_1^{-1} t_2^{-1} t_1, \quad w_2(\mathcal{S}) = t_2 .$$

Since in each product of the form $w_1(\mathcal{S})^{\pm 1} w_2(\mathcal{S})^{\pm 1}$ there cannot be cancellations, just as in the proof of Proposition 6.24 we can conclude that M does not admit any ∂_R -connected cut system. In particular, the handlebody H is $(3)_L$ -knotted, while being obviously $(4)_L$ -unknotted.

6.13. The maximal free covering. Let H be a spatial handlebody, set as usual $M = \mathbf{C}(H)$ and suppose that $\text{cut}(M) = 2$. Under this assumption, we are now going to describe the *maximal free covering* \widetilde{M}_ω of M . As mentioned at the beginning of the Section, we will discuss some aspects of the topology of \widetilde{M}_ω which are related to the knotting level of H .

Let $\mathcal{S} = \{S_1, S_2\}$ be any cut system of M , and let V be the manifold with boundary obtained by cutting M along \mathcal{S} . Then, the boundary of V consists of some ‘‘horizontal’’ boundary region (given by $\partial M \cap \partial V$) and some ‘‘vertical’’ boundary region, coming from the cuts along S_1 and S_2 . More precisely, recall that S_i is oriented, and call S_i^+ , S_i^- the vertical components of ∂V associated to S_i , $i = 1, 2$, in such a way that at any point of S_i a positive basis of the tangent space of S_i is completed to a positive basis of the tangent space of M by adding a vector pointing towards S_i^+ .

Let us set $G = \pi_1(M, x_0)$, where x_0 is a basepoint such that $x_0 \in \partial M \setminus (S_1 \cup S_2)$, let $F_2 = F(t_1, t_2)$ be the free group on two generators, and denote by $\varphi: G \rightarrow F_2$ the epimorphism associated to \mathcal{S} .

Let $p_\omega: \widetilde{M}_\omega \rightarrow M$ be the covering associated to $\ker \varphi$. The space \widetilde{M}_ω admits an easy topological description as a tree of spaces (called *pieces*), where each piece is homeomorphic to V . If $\{V_h\}_{h \in F_2}$ is a countable family of copies of V indexed by the elements of F_2 , then \widetilde{M}_ω is homeomorphic to the quotient of the disjoint union $\bigsqcup_{h \in F_2} V_h$ by the equivalence relation generated by

$$V_h \ni x \sim y \in V_{h'} \iff h' = h_i h, \quad x \in S_i^- \subseteq V_h, \quad y \in S_i^+ \subseteq V_{h'}, \quad \text{and } x = y \text{ in } M ,$$

where we now consider M as the space obtained from any V_h by gluing in pairs its vertical boundary components.

The group of the covering automorphisms of \widetilde{M}_ω is isomorphic to F_2 , and for every $h_0, h \in F_2$ the covering translation associated to h_0 translates V_h onto its copy $V_{h_0 h}$.

The notation \widetilde{M}_ω is justified by Theorem 6.1, which states that $\ker \varphi = G_\omega$, and implies that the topology of \widetilde{M}_ω does not depend on the particular epimorphism φ , nor on the chosen cut system \mathcal{S} , and is therefore intrinsically associated to M (whence to H). The covering $p_\omega: \widetilde{M}_\omega \rightarrow M$ is called the *maximal free covering* of M because the group of the covering automorphisms of \widetilde{M}_ω is isomorphic to the maximal free quotient of G .

The proof of the following Lemma is elementary, and it is left to the reader.

Lemma 6.25. *Suppose $X \subseteq M$ is path-connected, choose a base point $x_0 \in X \subseteq M$ and denote by $i: X \rightarrow M$ the inclusion. Let $p: (\widehat{M}, \widehat{x}_0) \rightarrow (M, x_0)$ be a regular covering, and set $\widehat{X} = p^{-1}(X)$. Then \widehat{X} is path-connected if and only if $p_*(\pi_1(\widehat{M}, \widehat{x}_0)) \cdot i_*(\pi_1(X, x_0))$ coincides with the whole group $\pi_1(M, x_0)$.*

We now apply the previous Lemma to the case we are interested in. The following result provides an interesting relation between the topology of \widetilde{M}_ω and the knotting level of H .

Proposition 6.26. *The subspace $\partial\widetilde{M}_\omega$ of \widetilde{M}_ω is path connected if and only if M admits a $(M \rightarrow W)$ -boundary-preserving-map.*

Proof. There is an elementary topological proof of the fact that if M admits a ∂ -connected cut system \mathcal{S} , then $\partial\widetilde{M}_\omega$ is connected. In fact, in this case the horizontal boundary of $V = M \setminus \mathcal{S}$ is connected. Therefore, the boundary of \widetilde{M}_ω is obtained by gluing connected spaces following a tree-like pattern, and is therefore connected.

To get both implications it is sufficient to observe that Lemma 6.25 implies that $\partial\widetilde{M}_\omega$ is connected if and only if $G = i_*(G_\partial) \cdot G_\omega$, and Proposition 6.6 ensures that this last condition is equivalent to the fact that M admits a $(M \rightarrow W)$ -boundary-preserving-map. \square

6.14. Lifts of longitudes. If $X = \mathbb{C}(L)$ is the complement of a 2-component homology boundary link and \mathcal{S} is a cut system of X , we can construct in the same way as above the maximal free covering \widetilde{X}_ω of X . Of course, since ∂X is disconnected, the space $\partial\widetilde{X}_\omega$ cannot be connected. Also observe that every connected component of $\partial\widetilde{X}_\omega$ is obtained by gluing to each other an infinite number of annuli, and is therefore homeomorphic to an annulus.

Recall that a *longitude* of L is (the isotopy class in ∂X of) a connected component of $\partial\mathcal{S}$. Every longitude lifts to a loop in $\partial\widetilde{X}_\omega$ which generates the first homology group of the annular component of $\partial\widetilde{X}_\omega$ where it lies. Since two non-trivial simple loops on an annulus are isotopic, this readily implies the already mentioned fact that longitudes do not depend on the fixed cut system \mathcal{S} . Moreover, since S_1 and S_2 also lift to \widetilde{X}_ω , if ∂S_1 and ∂S_2 are connected then every lift of a longitude bounds in \widetilde{X}_ω , and is therefore null-homologous in \widetilde{X}_ω . We can summarize this brief discussion in the following well-known:

Lemma 6.27. *The \mathbb{Z} -module $H_1(\partial\widetilde{X}_\omega)$ is generated by the lifts of the longitudes of ∂X . If L is a boundary link, then $\widetilde{i}_*(H_1(\partial\widetilde{X}_\omega)) = 0$, where \widetilde{i}_* is induced by the inclusion $\widetilde{i}: \partial\widetilde{X}_\omega \rightarrow \widetilde{X}_\omega$.*

In Propositions 6.28 and 6.29 below we extend Lemma 6.27 to the case when $M = \mathbb{C}(H)$ is the complement of a handlebody H such that $\text{cut}(M) = 2$, thus obtaining some more obstructions for M to admit ∂ -connected or ∂_R -connected boundary. Notice that some difficulties arise due to the fact that in this case the definition of longitudes is less obvious, and longitudes are in fact no more independent of the choice of a cut system.

If \mathcal{S} is a good cut system for M , let us define $L(\mathcal{S}) \subseteq H_1(\partial\widetilde{M}_\omega)$ as the submodule generated by the lifts to $\partial\widetilde{M}_\omega$ of the longitudes of \mathcal{S} . We also denote by $\varphi: \pi_1(M, x_0) \rightarrow F_2$ the epimorphism induced by \mathcal{S} , where x_0 is a basepoint in $\partial M \setminus (S_1 \cup S_2)$.

Proposition 6.28. *We have $L(\mathcal{S}) = H_1(\partial\widetilde{M}_\omega)$. In particular, $L(\mathcal{S})$ does not depend on \mathcal{S} .*

Proof. Take a basepoint $\widetilde{x}_0 \in p_\omega^{-1}(x_0) \subseteq \partial\widetilde{M}_\omega$, and let $\partial_0\widetilde{M}_\omega$ be the connected component of $\partial\widetilde{M}_\omega$ containing \widetilde{x}_0 . Since the maximal free covering is regular, it is sufficient to show that $H_1(\partial_0\widetilde{M}_\omega)$ is generated by those lifts of longitudes of \mathcal{S} that lie on $\partial_0\widetilde{M}_\omega$.

So, let us take $z \in H_1(\partial_0\widetilde{M}_\omega)$. By Hurewicz's Theorem we may suppose that z is represented by (the class of) a loop $\widetilde{\gamma} \in \pi_1(\partial_0\widetilde{M}_\omega, \widetilde{x}_0)$. Let now $i: \partial M \rightarrow M$, $\widetilde{i}_0: \partial_0\widetilde{M}_\omega \rightarrow \widetilde{M}_\omega$ be the

inclusions, let us denote the restriction of p_ω to $\partial_0 \widetilde{M}_\omega$ simply by p_ω , and set $\gamma = (p_\omega)_*(\tilde{\gamma}) \in \pi_1(\partial M, x_0)$. Since $p_\omega \circ \tilde{i}_0 = i \circ p_\omega$ and $(p_\omega)_*(\pi_1(\widetilde{M}_\omega, \tilde{x}_0)) = \ker \varphi$, we have $\gamma \in \ker \varphi \circ i_*$.

Let now γ_1, γ_2 be elements of $\pi_1(\partial M, x_0)$ which are represented by simple loops isotopic to the longitudes of \mathcal{S} , and recall from Lemma 6.11–(3) that $\ker \varphi \circ i_*$ coincides with the smallest normal subgroup of $\pi_1(\partial M, x_0)$ containing γ_1, γ_2 . Therefore, γ is a product of conjugates of γ_1, γ_2 in $\pi_1(\partial M, x_0)$, so $\tilde{\gamma}$ is a product of loops each of which is homologous to the lift of a longitude. This implies that $z \in L(\mathcal{S})$, whence the conclusion. \square

6.15. The image of $H_1(\partial \widetilde{M}_\omega)$ in $H_1(\widetilde{M}_\omega)$ as an obstruction. Recall that the group of the covering automorphisms of \widetilde{M}_ω is isomorphic to the free group F_2 . Therefore, both $H_1(\partial \widetilde{M}_\omega)$ and $H_1(\widetilde{M}_\omega)$ admit a natural structure of $\mathbb{Z}F_2$ -module, where $\mathbb{Z}F_2$ is the group ring of F_2 . Moreover, if $\tilde{i}: \partial \widetilde{M}_\omega \rightarrow \widetilde{M}_\omega$ is the inclusion, then $\tilde{i}_*: H_1(\partial \widetilde{M}_\omega) \rightarrow H_1(\widetilde{M}_\omega)$ is a homomorphism of $\mathbb{Z}F_2$ -modules, so $\tilde{i}_*(H_1(\partial \widetilde{M}_\omega))$ is a $\mathbb{Z}F_2$ -submodule of $H_1(\widetilde{M}_\omega)$.

We are now ready to point out a further topological obstruction to the existence of ∂ -connected and ∂_R -connected cut systems for M .

Proposition 6.29. *The following facts hold:*

- (1) *If M admits a ∂ -connected cut system, then $\tilde{i}_*(H_1(\partial \widetilde{M}_\omega)) = \{0\}$.*
- (2) *If M admits a ∂_R -connected cut system, then $\tilde{i}_*(H_1(\partial \widetilde{M}_\omega))$ is a cyclic $\mathbb{Z}F_2$ -module.*

Proof. (1): By Proposition 6.28, $H_1(\partial \widetilde{M}_\omega)$ is generated by the lifts of the longitudes. But, since ∂S_i is connected for $i = 1, 2$, the longitudes bound in \widetilde{M}_ω , whence the conclusion.

(2): Let \mathcal{S} be a ∂_R -connected cut system for M with longitudes ℓ_1, ℓ_2 . By point (1), we may assume that $\partial \mathcal{S} \setminus \partial_R \mathcal{S}$ is a non-empty collection of simple loops. Let ℓ_3 be one of these loops, and observe that ℓ_3 lifts to a loop $\tilde{\ell}_3$ in $\partial \widetilde{M}_\omega$. For $i = 1, 2$, since \mathcal{S} is ∂_R -connected and S_i lifts to \widetilde{M}_ω , every lift of ℓ_i is homologous in \widetilde{M}_ω to a sum of parallel copies of translates of $\tilde{\ell}_3$ (such a sum is empty if ∂S_i is connected). This implies that every lift of a longitude of \mathcal{S} lies in the cyclic $\mathbb{Z}F_2$ -submodule of $H_1(\partial \widetilde{M}_\omega)$ generated by $\tilde{\ell}_3$. The conclusion now follows from Proposition 6.28. \square

Corollary 6.30. *Let H be a spatial handlebody, set $M = C(H)$ and suppose that $\text{cut}(M) = 2$. Then:*

- (1) *If H is $(3)_S$ -unknotted, then $\tilde{i}_*(H_1(\partial \widetilde{M}_\omega)) = \{0\}$.*
- (2) *If H is $(3)_L$ -unknotted, then $\tilde{i}_*(H_1(\partial \widetilde{M}_\omega))$ is cyclic (as a $\mathbb{Z}F_2$ -module).*

Remark 6.31. Alexander-type obstructions, which will be described in Section 8, arise from the analysis of the *maximal abelian covering* \widetilde{M} of M . One may wonder if the arguments developed in this Section could take place in that (more classical) context, but this does not seem the case.

For example, an easy application of Lemma 6.25 implies that $\partial \widetilde{M}$ is always connected (even if $\text{cut}(M) = 1$), so that the maximal abelian covering cannot provide obstructions as the one described in Proposition 6.26.

Moreover, while the last results of this Section are inspired by analogous results for links, it turns out that the maximal abelian covering of a handlebody complement (having maximal cut number) displays properties quite dissimilar from the ones of maximal abelian coverings of (homology boundary) links. For instance, while Lemma 6.27 (which concerns links) also holds when the maximal free covering is replaced by the maximal abelian one, even when H is unknotted the image of $H_1(\partial \widetilde{M})$ into $H_1(\widetilde{M})$ does not vanish, so Proposition 6.29 and Corollary 6.30 do not admit analogous statements if \widetilde{M}_ω is replaced by \widetilde{M} .

In the case of (the complement of) homology boundary links, the structure of the first homology group of the maximal free covering as a $\mathbb{Z}F_2$ -module is studied in detail in [20].

7. EXTRINSIC VS INTRINSIC LEVELS OF KNOTTING

In this Section we investigate the implications that the existence of ∂ -connected or ∂_R -connected cut systems for $M = C(H)$ has on the knotting level of H . Since the existence of such cut systems is clearly an intrinsic property of M , this issue mainly concerns the relations between the intrinsic and the extrinsic properties of handlebody complements.

More precisely, recall that if H is $(3)_S$ -unknotted (resp. $(3)_L$ -unknotted), then M admits a ∂ -connected (resp. ∂_R -connected) cut system. We now face the question whether also the converse implications are true.

Definition 7.1. Let $M = C(H)$ as usual. A cut system $\mathcal{S} = \{S_1, S_2\}$ of M is said *H-separated* if there exists a simple essential curve ℓ on ∂M , such that:

- (1) ℓ separates ∂M ;
- (2) ℓ does not intersect $S_1 \cup S_2$;
- (3) ℓ bounds a compressing 2-disk in H .

It is not difficult to show that the map that associates to any spine Γ of H the boundary of the meridian disk dual to the isthmus of Γ establishes a bijection between the isotopy classes (in H) of (hc)-spines of H and the isotopy classes (in ∂H) of the loops ℓ satisfying properties (1) and (3) described in Definition 7.1 above. Building on this remark, it is not difficult to prove the following:

Lemma 7.2. *Let $M = C(H)$ be as usual. Then:*

- (a) *H is $(3)_S$ -unknotted if and only if M admits a H -separated ∂ -connected cut system.*
- (b) *H is $(3)_L$ -unknotted if and only if M admits a H -separated ∂_R -connected cut system.*
- (c) *H is $(4)_L$ -unknotted if and only if M admits a H -separated cut system.*

On the other hand we can prove the following remarkable equivalence between extrinsic and intrinsic properties, which was stated as Theorem 3.11 in Section 3.6.

Theorem 7.3. *$M = C(H)$ admits a ∂ -connected cut system if and only if H is not $(3)_S$ -unknotted (equivalently, M admits a H -separated ∂ -connected cut system).*

Proof. By using a $(M \rightarrow W)$ -boundary-preserving-map $f : M \rightarrow W$ we can construct a degree-1 map $g : S^3 \rightarrow N := H \cup_f W$. It was remarked in [4] that such a 3-manifold N is a homotopy sphere. As the Poincaré conjecture holds true, then N is homeomorphic to S^3 and is endowed by construction with a Heegaard splitting (of genus 2). Since every Heegaard splitting of the sphere is trivial, W admits a H -separated ∂ -connected cut system (actually made by two 2-disks), say \mathcal{S} . We can put g transverse to \mathcal{S} , without modifying it on a neighbourhood of H . Then the pull-back of \mathcal{S} via g provides the required H -separated cut system of M . \square

Remark 7.4. By [5], every 3-manifold with a Heegaard splitting of genus two is a two-sheeted cyclic branched cover of S^3 branched over a knot or link. This reconduces the validity of the Poincaré conjecture for manifolds of genus at most two to the positive solution to the Smith conjecture [37]. However, a statement similar to Theorem 7.3 holds for H of arbitrary genus (see below), and in such a generality it is very close to be equivalent to the full Poincaré conjecture. This remark strongly suggests that the issue of characterizing the relations between intrinsic and extrinsic properties of spatial handlebodies definitely involves deep results in 3-dimensional topology.

Remark 7.5. In general a given ∂ -connected cut system is *not* H -separated. For example let H be unknotted. Then also $M = C(H)$ is a handlebody. Let us take a (hc)-spine Γ of M such that at least one component of L_Γ is non-trivial (see *e.g.* Figure 4). We claim that the compression disks D_1, D_2 of M dual to the components of L_Γ form a ∂ -connected cut system of M which is not H -separated. In fact, suppose that $D'_3 \subseteq H$ is a separating meridian disk whose boundary is disjoint from $\partial D_1 \cup \partial D_2$. Now, cutting M along $D_1 \cup D_2$ we obtain a ball, so $\partial D'_3$ bounds a meridian disk $D_3 \subseteq M$ separating M and disjoint from $D_1 \cup D_2$. The 2-sphere $D_3 \cup D'_3$ is a reducing sphere for the Heegaard splitting $S^3 = M \cup H$, and the components of L_Γ appear now as cores of tori of a genus-1 Heegaard splittings of S^3 . This implies that both the components of L_Γ are unknotted, a contradiction.

Also observe that if both components of L_Γ are unknotted, then for $i = 1, 2$ the loop $\partial D_i \subseteq \partial M = \partial H$ cannot transversely intersect in exactly one point the boundary $\partial D'_i$ of a meridian disk $D'_i \subseteq H$ (otherwise, by compressing M along D_i one would get a genus-1 Heegaard splitting of S^3 , so the component of L_Γ dual to D_j , $j \neq i$, would be unknotted). This readily implies that the standard pair of longitudes of M (*i.e.* the pair associated to the compressing disks dual to the constituent link of an unknotted spine for M) and the pair of longitudes associated to the cut system $\{D_1, D_2\}$ have no element in common.

8. ALEXANDER MODULE OBSTRUCTIONS

In this Section we will recognize obstructions having a much more classical flavour as they are based on the *elementary determinantal ideal* $E_2(G)$ derived from any presentation of the *Alexander module* $A(G)$ of the fundamental group G of $M = C(H)$. Note that every invariant arising in this way is forced to detect only *intrinsic* features of M , *i.e.* only properties that do not depend on the realization of M as a cube-with-holes. The main result proved in this Section is Theorem 3.13, which states that there exists an infinite family of handlebodies $\{H_i\}_{i \in I}$ such that every $M_i = C(H_i)$ has cut number equal to 1 (hence H_i is $(4)_L$ -knotted), and M_i is not homeomorphic to M_j for $i \neq j$. However, this Section is mainly devoted to discuss in detail how Alexander invariants can provide obstructions to the existence both of generic and of ∂ -connected cut systems: such obstructions are described in Proposition 8.7, and applied in Propositions 8.18 and 8.19. More precisely, in Proposition 8.18 we give a different proof of Proposition 6.23, which asserts that the handlebodies $H_3(p)$ introduced in Subsection 5.6 are $(3)_S$ -knotted, while in Proposition 8.19 we prove that the complement of Kinoshita's graph (see Figure 26 below) has cut number equal to one.

8.1. A short account about the existing literature. The graph Γ_K of Figure 26 is the so-called *Kinoshita θ -graph* [28]. It is the spine of the spatial handlebody H_K , whose complement $C(H_K)$ will be denoted by M_K .

In [28] Kinoshita introduced some elementary ideals $E_d(\Gamma, z)$ associated to any presentation of the Alexander module of the fundamental group of $S^3 \setminus \Gamma$. These ideals turn out to be isotopy invariants for the couple (Γ, z) , where Γ is a spatial *graph* (not necessarily of genus 2) endowed with a given \mathbb{Z} -cycle z . By means of these invariants he proved for example that “his” graph Γ_K is knotted.

The Kinoshita θ -graph has several nice properties and since [28] does occur in several papers in order to test, for example, whether or not certain invariants are able to distinguish it from the unknotted θ -graph. An interesting property of Γ_K is that all its constituent knots are unknotted (one says that it is a “minimally knotted” graph), so the unknotting criterium of [39] applies and one can conclude that:

The Kinoshita's θ -graph Γ_K is knotted if and only if the handlebody H_K is $(1)_S$ -knotted.

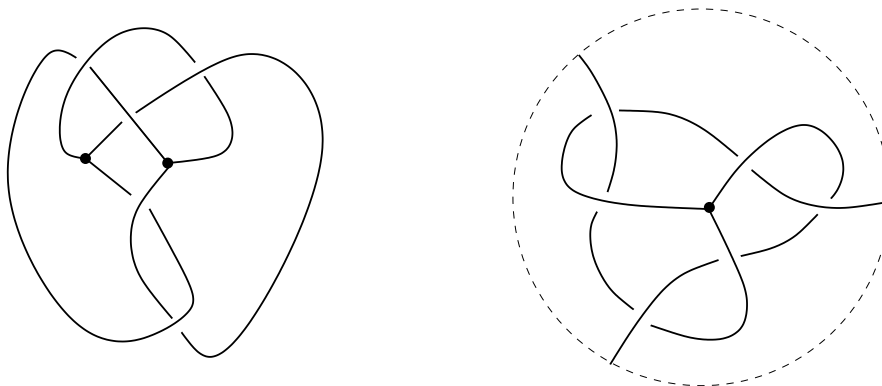

FIGURE 26. On the left, Kinoshita’s θ -graph. On the right, Thurston’s knotted wye: the second vertex is understood to be at infinity, in such a way that the complement of a regular neighbourhood of the graph coincides with the complement in a ball of a regular neighbourhood of the tangle here described.

This is a rather exceptional behaviour, because we know that in general the knotting of a given spine does not imply the $(1)_S$ -knotting of the associated handlebody. On the other hand, as observed in [53], Kinoshita’s θ -graph is isotopic to the “knotted wye” graph introduced by Thurston in [49, Example 3.3.12], where it is also shown that the manifold $M_K = \mathcal{C}(H_K)$ admits a hyperbolic structure with geodesic boundary (in fact, it turns out that M_K is the hyperbolic 3-manifold with geodesic boundary of smallest volume [29] and smallest complexity [16]). This implies that the boundary of M_K is incompressible, hence Proposition 4.3 does apply, and H_K is (at least) $(2)_S$ -knotted. For these reasons it is natural to look for the true level of knotting of H_K .

The first example of a genus 2 cube-with-holes $M = \mathcal{C}(H)$ not admitting any $(M \rightarrow W)$ -boundary-preserving-map is due to Lambert [30]. In fact, Lambert’s example coincides with the handlebody H associated to the spine of Figure 7, equivalently $H = H_1(3)$. The proof in [30] is of topological nature, based on an accurate analysis of such a specific example.

The first example of a genus 2 cube-with-holes $M = \mathcal{C}(H)$ having cut number equal to 1 is due to Jaco [26]. The discussion of this example exploits the following topological obstruction to be of corank 2: *If M has corank equal to 2, then every map $f : M \rightarrow S^1 \times S^1$ is homotopic to a non-surjective map.* This obstruction looks (at least to us) not so handy in order to discuss other examples.

In [46] the author remarked that Kinoshita’s invariants (and some variations of them) can be used to face questions concerning the cut number of M or the existence of $(M \rightarrow W)$ -boundary-preserving-maps. As applications he gave a different proof of the fact that Lambert’s example does not admit any $(M \rightarrow W)$ -boundary-preserving-map, and proved that $\text{cut}(M_K) = 1$. In [46] Suzuki adopts Kinoshita’s set up, in terms of spatial graphs endowed with \mathbb{Z} -cycles. The fact that one is actually working up to spine moves is somehow implicit. Moreover, sometimes the proofs simply refer to different sources strewn in the literature, where formally analogous statements had been previously achieved in the classical case of (boundary as well as homology boundary) links. For these reasons we have preferred to provide below an essentially self-contained, detailed account about these “Alexander module obstructions”, adopting as much as possible an intrinsic, geometric approach. By the way, we will point out the analogies but also some remarkable differences between the case of genus 2 cubes-with-holes and the case of links. As usual we will limit to deal with the case of present

interest, although the discussion can be generalized. A detailed and comprehensive account on Alexander modules of groups and spaces is given in [20] (which is mainly concerned with links). Several algebraic results we are discussing here are proved in [20] in greater generality. However, in order to make our treatment as elementary as possible, when this does not imply a big waste of space, we provide proofs for the statements that are relevant to our purposes.

We stress that it is quite remarkable that *easily* computable obstructions are able to recognize in some case, like M_K , that the cut number is equal to 1. It is known that starting with the input of a *finite presentation* of a group G , the determination of its corank can be done *in principle* by means of an algorithm (see [33]). This is an important conceptual fact, however the time of execution of such a generic algorithm grows too fast with the input complexity, so this is not of practical utility, also dealing with rather simple examples. In some cases (as already remarked in [45]) one can associate to the finite presentation of G some pertinent 3-dimensional (triangulated) manifold, and try to exploit geometric/topological tools in order to simplify the determination of the corank. Note that in our situation the problem is 3-dimensional from the very beginning, and one can try to use for example the theory of *normal surfaces* in order to detect the potential cut systems (if any). To this respect M_K should appear rather promising as it admits a very simple minimal triangulation as well as simple presentations of the fundamental group. So we have tried for a while to treat M_K along this way. However, there is a complication due to the fact that the theory of normal surfaces *with boundary* deals with many more elementary local configurations with respect to the closed case. For example it is not hard to realize in this way, *by bare hands*, that M_K is “small”, *i.e.* that it does not contain any incompressible and not boundary parallel closed surface; on the other hand, the computation of the cut number becomes rather demanding, reasonably should need a computer aid, and eventually we have preferred to turn towards more handy obstructions.

8.2. The Alexander module. Let us denote by M either $M = \mathbf{C}(H)$ or $M = \mathbf{C}(L)$, H being as usual a genus 2 spatial handlebody, L being a m -component link (in fact we will refer mostly to the cases $m = 1, 2$). G denotes the fundamental group of M , and K the abelianized of G , *i.e.* $K = G/[G, G]$. We denote the operation of the abelian group K multiplicatively. By Hurewicz Theorem, there exists a *canonical* isomorphism $K \cong H_1(M)$. We denote by $\Lambda = \mathbb{Z}K$ the group ring of K .

Let $p_A^M: \widetilde{M} \rightarrow M$ be the *maximal abelian covering* of M , that is the one associated to $[G, G]$. Fix a base point $x_0 \in M$, and set $\widetilde{M}^0 = (p_A^M)^{-1}(x_0)$. The group of covering automorphisms of \widetilde{M} is canonically isomorphic to K , and acts on the pair $(\widetilde{M}; \widetilde{M}^0)$. Hence $H_1(\widetilde{M}; \widetilde{M}^0)$ admits a natural structure of Λ -module, denoted by $A(M)$, which is by definition the *Alexander module of M* . There are two important homomorphisms defined on Λ :

- (1) (*Augmentation map*) $\epsilon: \Lambda \rightarrow \mathbb{Z}$, which sends every element $\sum_i m_i k_i$, where $m_i \in \mathbb{Z}$ and $k_i \in K$, to the integer $\sum_i m_i$. Its kernel I is called the *augmentation ideal* of Λ .
- (2) (*Canonical involution*) $\sigma: \Lambda \rightarrow \Lambda$, which sends every element $\sum_i m_i k_i$ to $\sum_i m_i k_i^{-1}$ (the fact that σ is a homomorphism relies on the fact that K is abelian).

8.3. Finite presentations via free differential calculus. Let us briefly recall the definition of Fox derivative [15]. Suppose $F = F(x_1, \dots, x_n)$ is a free group on n generators. For $j = 1, \dots, n$, the Fox derivative

$$\partial_j: \mathbb{Z}F \rightarrow \mathbb{Z}F$$

is defined as the unique \mathbb{Z} -linear map such that

$$\partial_j(w \cdot w') = \partial_j w + w \cdot \partial_j w' \quad \forall w, w' \in F$$

and

$$\partial_j x_j = 1, \quad \partial_j x_j^{-1} = -x_j^{-1}, \quad \partial_j x_i^{\pm 1} = 0 \quad \forall i \neq j.$$

Let A be a Λ -module; A is *finitely presented* if it is isomorphic, as a Λ -module, to the quotient $\Lambda^n / \langle r_1, \dots, r_s \rangle$, where each r_i is an element of Λ^n , and $\langle r_1, \dots, r_s \rangle$ is the Λ -module generated by the r_i 's. If B is the $(s \times n)$ -matrix whose rows are given by the r_i 's, then we say that B is a *presentation matrix* for A .

Let M, G be as above. A proof of the following result can be found for example in [32]:

Theorem 8.1. *Let $\langle x_1, \dots, x_n \mid r_1, \dots, r_s \rangle$ be a presentation of G , and let $j: F(x_1, \dots, x_n) \rightarrow G$ and $k: G \rightarrow G/[G, G] = K$ be the natural projections. Then a matrix presentation of $A(M)$ is provided by the matrix $(B)_{il}$, where*

$$B_{il} = k(j(\partial_l r_i)), \quad i = 1, \dots, s, \quad l = 1, \dots, n.$$

In particular, this implies that, up to isomorphism, $A(M) := A(G)$ only depends on G , and it is finitely presented.

8.4. Elementary ideals. We briefly recall here the definition of elementary ideal of a finitely presented Λ -module. The interested reader can find a detailed account on this issue for instance in [20].

Let A be a finitely presented Λ -module with a given $(s \times n)$ presentation matrix B as above. For every $d \in \mathbb{N}$, let us now define the ideal $E_d(B) \subseteq \Lambda$ as follows:

- If $n - d > s$, then $E_d(B) = 0$;
- If $0 < n - d \leq s$, then $E_d(B)$ is the ideal generated by the determinants of the $(n - d) \times (n - d)$ minors of B ;
- If $n - d \leq 0$, then $E_d(B) = \Lambda$.

We have therefore $E_d(B) \subseteq E_{d+1}(B)$ for every $d \in \mathbb{N}$.

A well-known purely algebraic result on presentations of modules implies that $E_d(B)$ depends in fact only on A , so that for every $d \in \mathbb{N}$ the *Alexander elementary ideal* of A

$$E_d(A) := E_d(B)$$

is well-defined. The k -th *Alexander principal ideal* $\mathcal{P}_k(A)$ is the smallest principal ideal containing $E_k(A)$. Since Λ is a UFD, a generator $\Delta_k(A)$ of $\mathcal{P}_k(A)$, which is usually called the *k-th Alexander polynomial* of A is simply the greatest common divisor of any set of generators for $E_k(A)$.

We can apply these definitions to $A(M)$ so that the elementary ideals $E_k(M)$ as well as $\mathcal{P}_k(M)$ and $\Delta_k(M)$ are well defined topological invariants of M (actually depending only on the fundamental group G). In the case of a link L we also write $A(L), \dots, \Delta_k(L)$, instead of $A(M), \dots, \Delta_k(M)$.

The following Lemma is useful to study these invariants. Its proof only relies on elementary algebraic arguments involving the very definition of Alexander ideals.

Lemma 8.2. (1) *Suppose A is a finitely presented Λ -module. Then for every $d, k \in \mathbb{N}$ we have*

$$E_{d+k}(A \oplus \Lambda^k) = E_d(A).$$

(2) *Suppose*

$$0 \longrightarrow A_1 \xrightarrow{i} A_2 \xrightarrow{\pi} A_3 \longrightarrow 0$$

is an exact sequence of Λ -modules. Then

$$E_d(A_1)E_{d'}(A_3) \subseteq E_{d+d'}(A_2) \quad \text{for every } d, d' \in \mathbb{N}.$$

(3) Suppose B is a square presentation matrix for A of order n , and let

$$\text{Ann}(A) = \{\gamma \in \Lambda \mid \gamma(a) = 0 \forall a \in A\} \subseteq \Lambda$$

be the annihilator ideal of A . Then we have

$$E_0(A) \subseteq \text{Ann}(A).$$

Proof. Point (1) is an easy consequence of the fact that a presentation matrix for $A \oplus \Lambda^k$ is obtained by adding k null columns to a presentation matrix for A .

Points (2) and (3) are stated respectively as Theorem 3.12–(1) and Theorem 3.1–(1) in [20]. \square

8.5. Polynomial ideals. K is non-canonically isomorphic to \mathbb{Z}^m (where $m = 2$ when $M = \mathbb{C}(H)$, and m equals the number of components in the case of links). Let $\langle t_1, \dots, t_m \rangle$ be the multiplicative abelian group freely generated by the symbols t_1, \dots, t_m . Choosing an isomorphism $K \cong \langle t_1, \dots, t_m \rangle$ is equivalent to choosing a basis for $\text{Hom}(H_1(M), \mathbb{Z}) = H^1(M)$: in fact, since $K = H_1(M)$ is torsion-free of rank m , then to each basis l_1, \dots, l_m of $H^1(M)$ there is associated the isomorphism sending every $z \in H_1(M)$ to the monomial $t_1^{l_1(z)} \dots t_m^{l_m(z)}$, and every isomorphism $K \cong \langle t_1, \dots, t_m \rangle$ arises in this way. Every such an isomorphism canonically extends to a ring isomorphism between Λ and $\mathbb{Z}[t_1^{\pm 1}, \dots, t_m^{\pm 1}]$.

Alexander-Lefschetz duality provides a canonical isomorphism $H^1(M) \cong H_1(H) \cong H_1(\mathcal{L})$, where \mathcal{L} is either some $L_\Gamma \in \mathcal{L}(H)$ or L itself: every integral cycle in $H_1(\mathcal{L})$ defines a cohomology class in $H^1(M)$ via the linking number. Therefore, if c_1, \dots, c_m is a basis of $H_1(\mathcal{L})$, then the map $z \mapsto t_1^{\text{lk}(c_1, z)} \dots t_m^{\text{lk}(c_m, z)}$ provides an isomorphism between K and $\langle t_1, \dots, t_m \rangle$. If the components K_1, \dots, K_m of \mathcal{L} are ordered and oriented, then we can select the distinguished basis of $H_1(\mathcal{L})$ such that $c_j = \sum_j \delta_{ij} [K_j]$. Hence in the case of a ordered and oriented link L we have a distinguished isomorphisms between K and $\langle t_1, \dots, t_m \rangle$. On the other hand, one can prove the following:

Proposition 8.3. *If $M = \mathbb{C}(H)$ then, by varying the (hc)-spine Γ as well as the ordering and the orientation on L_Γ , every isomorphism between K and $\langle t_1, t_2 \rangle$ arises from the distinguished basis of some L_Γ .*

Proof. Of course, it is sufficient to show that every basis of $H_1(H)$ is represented by the (ordered and oriented) components of the constituent link of some spine of H . However, it is well-known that the group of homeomorphisms of H into itself acts transitively on the set of bases of $H_1(H)$ (see e.g. [6, Lemma 2.2]). Therefore, if Γ is any spine of H and \mathcal{B} is a fixed basis of $H_1(H)$, we may find a homeomorphism $\varphi: H \rightarrow H$ whose induced map in homology takes to \mathcal{B} the basis associated to L_Γ . This implies that \mathcal{B} is the distinguished basis associated to the spine $\varphi(\Gamma)$ of H . \square

Summing up, in the case of an ordered and oriented link L (in particular when L is an oriented knot) there is a canonical identification of $E_k(M)$, $\mathcal{P}_k(M)$ as polynomial ideals of $\mathbb{Z}[t_1^{\pm 1}, \dots, t_m^{\pm 1}]$, also denoted by Λ , and $\Delta_k(M)$ is called the k -th Alexander polynomial of L . In the case of $M = \mathbb{C}(H)$ such polynomial invariants are well defined only up to the natural action of $SL(2, \mathbb{Z})$ on $\mathbb{Z}[t_1^{\pm 1}, t_2^{\pm 1}]$.

Remark 8.4. Let $M = \mathbb{C}(H(\Gamma))$, G be as usual. Let $c \in H_1(\Gamma)$ be a non-trivial primitive homology class. The map $z \mapsto t^{\text{lk}(c, z)}$ defines a surjective homomorphism $\alpha_c: H_1(M) \rightarrow \langle t \rangle \cong \mathbb{Z}$, which induces in turn a ring homomorphism $\alpha_c: \Lambda \rightarrow \mathbb{Z}[t, t^{-1}]$. Since α_c is surjective, if B is a presentation matrix for $A(M)$ and $\alpha_c(B)$ is the matrix obtained by applying α_c to every coefficient of B , then $\alpha_c(E_d(M)) = E_d(\alpha_c(B))$ for every $d \in \mathbb{N}$ (see also [28, 46]). Let $p: \widehat{M} \rightarrow M$

be the covering associated to $\ker \alpha_c \circ \pi$, where $\pi: G \rightarrow H_1(M)$ is the Hurewicz epimorphism. Then, \widehat{M} is an infinite cyclic covering whose automorphism group is canonically isomorphic to $\langle t \rangle$. A slight variation of Theorem 8.1 implies that $\alpha_c(B)$ is a presentation matrix of $H_1(\widehat{M}, p^{-1}(x_0))$ as a $\mathbb{Z}[t, t^{-1}]$ -module, so the ideals $\alpha_c(E_d(M))$ are related to the topology of \widehat{M} . Starting from this consideration, in [9] (which is concerned with links) it is shown how one can deduce results about the ideals $E_d(M)$ starting from the study of all the infinite cyclic coverings of M . Note however that the polynomial $\alpha_c(\Delta_d(M))$ may be different from the generator $\Delta_d^c(M)$ of the smallest principal ideal containing $\alpha_c(E_d(M))$. More precisely, it is obvious that $\alpha_c(\Delta_d(M))$ divides $\Delta_d^c(M)$; however, if $E_d(M)$ is not principal, then it may happen that $\Delta_d^c(M)$ does not divide $\alpha_c(\Delta_d(M))$. For example, in the case when G is the fundamental group of the complement of a m -component (oriented) link L , $m \geq 2$, it is not difficult to show that if c is the cycle given by the sum of all the components of L , then $\Delta_d^c(L) = (t - 1) \cdot \alpha_c(\Delta_d(L))$ (see [9, Proposition 2.1]).

8.6. The absolute module of \widehat{M} . Instead of considering the module $A(M)$, one may consider the module $AA(M) = H_1(\widetilde{M})$ (the *absolute* Alexander module of M), as also $AA(M)$ admits a natural structure of Λ -module. The long exact sequence of the pair $(\widetilde{M}, \widetilde{M}^0)$ in homology provides a sequence of maps of Λ -modules which can be eventually written in the form

$$0 \longrightarrow AA(M) \longrightarrow A(M) \longrightarrow \Lambda \xrightarrow{\varepsilon} \mathbb{Z} \longrightarrow 0$$

or equivalently in the form

$$(4) \quad 0 \longrightarrow AA(M) \longrightarrow A(M) \longrightarrow I \longrightarrow 0.$$

Note that under any fixed isomorphism $\Lambda \cong \mathbb{Z}[t_1^{\pm 1}, \dots, t_m^{\pm 1}]$ as in the previous Section, the augmentation ideal I corresponds to $(t_1 - 1, \dots, t_m - 1)$. The sequence (4) is usually known as the *Crowell sequence* for $A(M)$.

8.7. The case of knots. When $M = C(L)$, L being an oriented *knot*, since I is a principal ideal, then $I \cong \Lambda = \mathbb{Z}[t^{\pm 1}]$, so the sequence (4) splits, and we have

$$(5) \quad A(L) \cong AA(L) \oplus \Lambda.$$

Putting together equation (5) and Lemma 8.2–(1) we obtain the following equalities between polynomial ideals

$$E_{k+1}(A(L)) = E_k(AA(L)) \quad \text{for every } k \geq 0.$$

Moreover, it is known that any Wirtinger presentation of G has deficiency one (see Definition 8.9), and defines therefore a presentation matrix B for $A(L)$ having n rows and $n + 1$ columns. Another property of Wirtinger presentations implies that the determinant of the square matrix obtained by omitting the i -th column of B does not depend (up to units in $\mathbb{Z}[t^{\pm 1}]$) on i , so $E_1(A(L))$ is principal. The generator of

$$E_1(A(L)) = E_0(AA(L))$$

is the classical *Alexander polynomial* of the knot.

In our cases of interest $M = C(H)$ or $M = C(L)$, L being a link, the Crowell sequence does not necessarily split, so the relation between $A(M)$ and $AA(M)$ is less direct. We will come back later to this issue.

8.8. Alexander obstructions. In this Section we focus on $M = \mathbf{C}(H)$.

Definition 8.5. Let J be an ideal of Λ .

- (1) We say that J is *unitary* if $\varepsilon(J) = \mathbb{Z}$, where $\varepsilon: \Lambda \rightarrow \mathbb{Z}$ is the augmentation map introduced above.
- (2) We say J is *symmetric* if $\sigma(J) = J$, where σ is the canonical involution introduced above.

The proof of the following easy Lemma is omitted.

Lemma 8.6. *Let us fix any isomorphism $\Lambda \cong \mathbb{Z}[t_1^{\pm 1}, t_2^{\pm 1}]$ (associated to the distinguished basis of some L_Γ as in Section 8.5). Assume that the ideal J is principal generated by the polynomial f . Then:*

- (1) J is unitary if and only if $f(1, 1) = \pm 1$.
- (2) J is symmetric if and only if $f(t_1, t_2) = \pm t_1^{a_1} t_2^{a_2} f(t_1^{-1}, t_2^{-1})$ for some $a_1, a_2 \in \mathbb{Z}$.

The following Proposition collects the most important properties of the elementary ideals of M , including those providing the promised ‘‘obstructions’’.

Proposition 8.7. *Let $M = \mathbf{C}(H)$, H being a genus 2 spatial handlebody. Then*

- (1) $E_0(M) = E_1(M) = 0$.
- (2) $E_2(M)$ is unitary. For every $L_\Gamma \in \mathcal{L}(H)$, we have $E_2(M) \subseteq E_2(L_\Gamma)$.
- (3) $E_2(M) = E_1(AA(M))$.
- (4) If $\text{crk}(\pi_1(M)) = 2$, then $E_2(M)$ is principal.
- (5) If M admits a ∂ -connected cut system (equivalently, M admits a $(M \rightarrow W)$ -boundary-preserving-map), then $E_2(M)$ is symmetric.

We devote most of the Section to the proof of this Proposition. More precisely, points (1) and (2) are proved in Subsection 8.9, point (3) in Subsection 8.10, point (4) in Proposition 8.12 (see Subsection 8.11), and point (5) in Corollary 8.17 (see Subsection 8.12).

Remark 8.8. To our purposes, the most relevant results described in Proposition 8.7 are points (4) and (5). Since $\pi_1(M)$ has deficiency 2 (see Lemma 8.10), point (4) can be deduced from [20, Theorem 4.3], which implies in fact the stronger result that $E_2(M)$ is principal if and only if $\pi_1(M)$ admits an epimorphism onto F_2/F_2'' , where $F_2 = [F_2', F_2']$ and $F_2'' = [F_2, F_2]$.

Moreover, in [46] point (5) is described as a consequence of the results of [19], which – however – are concerned only with links.

We have thus decided to include here a detailed account on how the argument in [19] can be adapted to the case of handlebody complements. In order to achieve this, it is necessary to introduce a machinery which allows us to give a self-contained proof also of point (4) without a too big waste of space.

We begin by pointing out some analogies and differences with respect to the case of links.

- (a) In the case of a link L , it is proved in [50] that for every $d \in \mathbb{N}$ there exist natural numbers k, h such that

$$E_d(AA(L)) \cdot I^k \subseteq E_{d+1}(A(L)), \quad E_{d+1}(A(L)) \cdot I^h \subseteq E_d(AA(L)).$$

Since the only principal ideal containing I is the whole ring Λ , this implies that for every $d \in \mathbb{N}$ we have the equality of Alexander polynomials

$$\Delta_d(AA(L)) = \Delta_{d+1}(A(L)).$$

- (b) Let L be any link. The following facts are proved in [48]:

- If L is a knot, then all the Alexander ideals $E_d(L)$, $d \in \mathbb{N}$ are symmetric;
- If L is a knot, then the Alexander polynomial $\Delta_1(L)$ satisfies

$$\Delta_1(t) = t^n \Delta_1(t^{-1}),$$

where n is even;

- If L has $m \geq 2$ components, then the *first* Alexander polynomial of L satisfies

$$\Delta_1(L)(t_1^{-1}, \dots, t_m^{-1}) = -t_1^{k_1-1} \dots t_m^{k_m-1} \Delta_1(t_1, \dots, t_m),$$

where k_i has the same parity of the sum of the linking numbers of L_i with all the other components of L .

A proof of these facts using Seifert surfaces can be found in [9].

- (c) If L is a 2-component *homology boundary* link, then $E_2(L)$ is not necessarily principal. According to [22], such an ideal is principal if and only if the image of $H_1(\partial \widetilde{M})$ in $H_1(\widetilde{M})$ vanishes. This last condition holds whenever L is a *boundary* link. These results are in sharp contrast with point (3) of Proposition 8.7 above.

8.9. Proofs of points (1) and (2) of Proposition 8.7. We begin with the following:

Definition 8.9. The *deficiency* of a finite presentation $\langle S | R \rangle$ of a group G is equal to the difference between the number $|S|$ of generators and the number $|R|$ of relations of the presentation. The deficiency of a finitely presented group G is the maximal deficiency of finite presentations of G (note that the deficiency of a group may be negative).

The following easy result is proved *e.g.* in [28, Theorem 7]:

Lemma 8.10. *The deficiency of the fundamental group G of $M = \mathbb{C}(H)$ is 2.*

Putting together Lemma 8.10 and Theorem 8.1 we deduce that $A(M)$ admits a $n \times (n+2)$ presentation matrix. Clearly this implies that $E_0(M) = E_1(M) = 0$.

Let us now show that $E_2(M)$ is unitary. It is not difficult to show that if $\langle x_1, \dots, x_g | r_1, \dots, r_s \rangle$ is a presentation of G and $a: F(x_1, \dots, x_g) \rightarrow \{1\}$ is the trivial homomorphism, then $a(\partial r_i / \partial x_j) \in \mathbb{Z}[\{1\}] = \mathbb{Z}$ computes the sum of the exponents of x_j in the word r_i . It readily follows that if B is a presentation matrix for $A(M)$, then applying ε to every element of B we obtain a presentation matrix for $G/[G, G] \cong \mathbb{Z}^2$. Since the presentation of $A(M)$ can be chosen of deficiency 2, say of the form $n \times (n+2)$, this implies that the GCD of the minors $n \times n$ of $\varepsilon(B)$ has to be 1. Then $\varepsilon(E_2(M)) = \mathbb{Z}$.

If Γ is a spine of H with constituent link L_Γ , then $\pi_1(S^3 \setminus L_\Gamma)$ is obtained by adding to any presentation of $\pi_1(M)$ a relation representing the boundary of a 2-handle dual to the isthmus of Γ . It follows that a presentation matrix for $A(L_\Gamma)$ is obtained by adding a row to a presentation matrix of $A(M)$, and this readily implies that $E_2(M) \subseteq E_2(L_\Gamma)$.

These facts already say that $E_2(M)$ is the first non-vanishing Alexander ideal of M . It is therefore not surprising that it encodes several geometric properties of M .

8.10. A relation between the ideals of $A(M)$ and of $AA(M)$. Let us prove now that $E_2(M) = E_1(AA(M))$. This is a consequence of the more general results proved in [50, 51]. For the sake of completeness, we describe here the proof in the case we are interested in.

We begin by computing the ideal $E_1(I)$. We fix an identification $\Lambda \cong \mathbb{Z}[t_1^{\pm 1}, t_2^{\pm 1}]$. Let us consider the exact sequence

$$(6) \quad 0 \longrightarrow \Lambda \xrightarrow{\alpha_1} \Lambda^2 \xrightarrow{\alpha_2} I \longrightarrow 0,$$

where $\alpha_1(p) = ((t_2 - 1)p, (1 - t_1)p)$ and $\alpha_2(p, q) = (t_1 - 1)p + (t_2 - 1)q$. The presentation matrix for I related to this exact sequence is given by $(t_2 - 1 \ 1 \ 1 - t_1)$, so $E_1(I) = I$.

Let us now show that $E_2(M) \subseteq E_1(AA(M))$. Since Λ and Λ^2 are free Λ -modules, we can arrange the short exact sequence (6) and the Crowell exact sequence for $A(M)$ in the commutative diagram

$$\begin{array}{ccccccccc} 0 & \longrightarrow & \Lambda & \xrightarrow{\alpha_1} & \Lambda^2 & \xrightarrow{\alpha_2} & I & \longrightarrow & 0 \\ & & \downarrow \beta & & \downarrow \gamma & & \downarrow \text{Id} & & \\ 0 & \longrightarrow & AA(M) & \xrightarrow{\varphi} & A(M) & \xrightarrow{\psi} & I & \longrightarrow & 0 \end{array}$$

It is now easy to check that the sequence

$$0 \longrightarrow \Lambda \xrightarrow{k} AA(M) \oplus \Lambda^2 \xrightarrow{h} A(M) \longrightarrow 0$$

is exact, where $k(p) = (-\beta(p), \alpha_1(p))$ and $h(a, (p, q)) = \varphi(a) + \gamma(p, q)$. We may now apply Lemma 8.2, thus obtaining

$$E_2(A(M)) = E_2(A(M)) \cdot E_1(\Lambda) \subseteq E_3(AA(M) \oplus \Lambda^2) = E_1(AA(M)).$$

In order to show the opposite inclusion, let us introduce the following notation: if J, J' are ideals of Λ , then we set

$$(J : J') = \{\lambda \in \Lambda \mid \lambda \cdot J' \subseteq J\}.$$

Since $E_2(M)$ is unitary we have $E_2(M) + I = \Lambda$. As a consequence, for every ideal J of Λ we have

$$E_2(M) + J = (E_2(M) + J) \cdot (E_2(M) + I) \subseteq E_2(M) + J \cdot I \subseteq E_2(M) + J,$$

whence $E_2(M) + J = E_2(M) + J \cdot I$. Applying this equality to the case $J = (E_2(M) : I)$ we obtain

$$E_2(M) + (E_2(M) : I) = E_2(M) + (E_2(M) : I) \cdot I \subseteq E_2(M) + E_2(M) = E_2(M),$$

whence

$$(7) \quad E_2(M) = (E_2(M) : I).$$

Now, by applying Lemma 8.2–(2) to the Crowell sequence for $A(M)$ we have $E_1(AA(M)) \cdot I = E_1(AA(M)) \cdot E_1(I) \subseteq E_2(M)$. Together with equation (7), this finally implies

$$E_1(AA(M)) \subseteq ((E_1(AA(M)) \cdot I) : I) \subseteq (E_2(M) : I) = E_2(M).$$

8.11. The case when $\text{cut}(M) = 2$. Assume now that $\text{cut}(M) = 2$. Let Y be the figure-eight graph $S^1 \vee S^1$ and denote by y_0 the singular point of Y . We also choose a base point $x_0 \in M$. Then $G = \pi_1(M, x_0)$ admits an epimorphism onto $F_2 = \mathbb{Z} * \mathbb{Z} = \pi_1(Y, y_0)$. Then, there exist continuous maps $f: M \rightarrow Y$ and $g: Y \rightarrow M$ such that $f \circ g$ is the identity of Y . We may also assume that $f(x_0) = y_0$ and $g(y_0) = x_0$.

Let $p_A^Y: \tilde{Y} \rightarrow Y$ be the covering associated to $[F_2, F_2]$. Since $f_*([G, G]) \subseteq [F_2, F_2]$ and $g_*([F_2, F_2]) \subseteq [G, G]$, the maps f and g lift to continuous maps $\tilde{f}: \tilde{M} \rightarrow \tilde{Y}$, $\tilde{g}: \tilde{Y} \rightarrow \tilde{M}$ which can be chosen in such a way that $\tilde{f} \circ \tilde{g} = \text{Id}_{\tilde{Y}}$.

Let us now consider the relative homology group $A(F_2) = H_1(\tilde{Y}; (p_A^Y)^{-1}(y_0))$. Observe that f_* induces an isomorphism between $K = G/[G, G]$ and $F_2/[F_2, F_2]$, which is in turn canonically isomorphic to the group of covering automorphisms of \tilde{Y} . As a consequence, we may consider the induced action of K also on the pair $(\tilde{Y}; (p_A^Y)^{-1}(y_0))$. We have therefore that also $A(F_2)$ admits a natural structure of Λ -module.

By construction, the maps \tilde{f} and \tilde{g} commute with the action of K on \tilde{M} and \tilde{Y} , so $\varphi := \tilde{f}_*: A(M) \rightarrow A(F_2)$ and $\psi := \tilde{g}_*: A(F_2) \rightarrow A(M)$ provide morphisms of Λ -modules such that $\psi \circ \varphi = \text{Id}_{A(F_2)}$.

$$\begin{array}{ccc} \tilde{M} & \begin{array}{c} \xrightarrow{\tilde{f}} \\ \xleftarrow{\tilde{g}} \end{array} & \tilde{Y} \\ \downarrow & & \downarrow \\ M & \begin{array}{c} \xrightarrow{f} \\ \xleftarrow{g} \end{array} & Y, \end{array} \quad A(M) \begin{array}{c} \xrightarrow{\varphi} \\ \xleftarrow{\psi} \end{array} A(F_2).$$

Lemma 8.11. *We have $A(M) \cong \Lambda^2 \oplus \ker \varphi$. In particular, $\ker \varphi$ is a finitely-presented Λ -module, and $E_2(M) = E_0(\ker \varphi)$.*

Proof. First observe that since $\psi \circ \varphi = \text{Id}_{A(F_2)}$ we have $A(M) \cong A(F_2) \oplus \ker \varphi$, so in order to prove the first assertion it is sufficient to observe that $A(F_2) \cong \Lambda^2$ (this is a consequence, for example, of Theorem 8.1).

Since $A(M)$ is finitely presented and $A(M) \cong \Lambda^2 \oplus \ker \varphi$, also $\ker \varphi$ is finitely presented, and now the conclusion follows from Lemma 8.2-(1). \square

A result of Stallings ensures that the kernel of any surjection of $\pi_1(M)$ onto F_2 does not depend on the chosen surjection (see Theorem 6.1 below). Therefore, $\ker \varphi \subseteq A(M)$ admits an intrinsic characterization, which is actually independent from φ . However, we show in Proposition 8.12 below how this characterization can be obtained without relying on Stallings' results.

Let us define the *torsion submodule* $T(M)$ of $A(M)$ as follows:

$$T(M) = \{a \in A(M) \mid \gamma(a) = 0 \text{ for some } \gamma \in \Lambda \setminus \{0\}\}.$$

The following Proposition implies point (4) of Proposition 8.7.

Proposition 8.12. *We have $T(M) = \ker \varphi$. Moreover,*

- (1) $T(M) = \ker \varphi$;
- (2) $T(M)$ is finitely presented, and $A(M) \cong \Lambda^2 \oplus T(M)$;
- (3) $E_2(M) = E_0(T(M))$;
- (4) $E_2(M)$ is principal.

Proof. By Lemmas 8.11 and 8.2 we have that $\Delta_2(M) = \Delta_0(\ker \varphi) \in E_0(\ker \varphi) \subseteq \text{Ann}(\ker \varphi)$. Moreover, since $E_2(M)$ is unitary, the Alexander polynomial $\Delta_2(M)$ cannot be null, and these facts imply that $\ker \varphi$ is contained in $T(M)$. On the other hand, since $A(M) = \Lambda^2 \oplus \ker \varphi$ we also have $T(M) \subseteq \ker \varphi$, whence (1). Having proved (1), points (2) and (3) are simply a restatement of Lemma 8.11. By Lemma 8.10 and Theorem 8.1, the module $A(M)$ admits a presentation of deficiency two. Since $A(M) \cong \Lambda^2 \oplus \ker \varphi$, this readily implies that $\ker \varphi$ admits a square presentation matrix, and this implies in turn that $E_0(\ker \varphi)$ is principal, whence (4). \square

8.12. The case when M admits a ∂ -connected cut system. The proof of the last point of Proposition 8.7 is a bit more demanding and incorporates more geometric insight about $E_2(M)$. We follow here the strategy described in [19], where the case of (complements of) boundary links is treated.

Assume as above that $\text{cut}(M) = 2$, and let us fix a cut system $\mathcal{S} = \{S_1, S_2\}$ on M . We can assume that the base point x_0 of M does not lie on the union $S_1 \cup S_2$. Then, just as the

maximal free covering \widetilde{M}_ω introduced in Section 6, also the covering \widetilde{M} admits a concrete description in terms of the topology of $M \setminus (S_1 \cup S_2)$.

So, let V and S_i^\pm be defined as in Subsection 6.13, and let us denote by k_i the element of $K = H_1(M)$ satisfying $k_i \cap S_j = \delta_{ij}$, $i, j = 1, 2$. Then, any loop representing k_i and intersecting S_i transversely in one point runs from S_i^- to S_i^+ in a regular neighbourhood of S_i , and from S_i^+ to S_i^- in V . Let us also consider the disjoint union of a countable number $\{V_k\}_{k \in K}$ of copies of V , indexed by the elements of $K = G/[G, G]$, and let us take the quotient of such a union under the equivalence relation generated by

$$V_k \ni x \sim y \in V_{k'} \iff k' = k_i k, x \in S_i^- \subseteq V_k, y \in S_i^+ \subseteq V_{k'}, \text{ and } x = y \text{ in } M.$$

It is now easy to recognize that such a quotient is homeomorphic to \widetilde{M} . Also observe that the action of K on \widetilde{M} admits a very easy description: for every $k_0 \in K$, the covering translation associated to k_0 translates V_k onto its copy $V_{k_0 k}$, for every $k \in K$.

By Lemma 8.11, the ideal $E_2(M)$ is equal to the ideal $E_0(\ker \varphi)$. In what follows, we denote by $\widetilde{\mathcal{S}}$ the set $(p_A^M)^{-1}(S_1 \cup S_2) \subseteq \widetilde{M}$.

Lemma 8.13. *We have*

$$\ker \varphi = T(M) \cong \text{Im} \left(i_* : H_1(\widetilde{M} \setminus \widetilde{\mathcal{S}}) \rightarrow H_1(\widetilde{M}) \right).$$

Proof. The Crowell sequences for the Alexander modules of $A(M)$ and of $A(F_2)$, together with the epimorphism $\varphi: G \rightarrow F_2$, gives rise to the following commutative diagram, where rows are exact and the last vertical arrow is an isomorphism:

$$\begin{array}{ccccccc} 0 & \longrightarrow & H_1(\widetilde{M}) = G/[G, G] & \longrightarrow & A(M) & \longrightarrow & \Lambda \\ & & \downarrow \tilde{f}_* & & \downarrow \varphi & & \downarrow \cong \\ 0 & \longrightarrow & H_1(\widetilde{Y}) = F_2/[F_2, F_2] & \longrightarrow & A(F_2) & \longrightarrow & \Lambda \end{array}$$

and this easily implies (by chasing the diagram) that $T(M) = \ker \varphi$ is isomorphic to $\ker \tilde{f}_*$.

Let us fix an identification of K with \mathbb{Z}^2 , set

$$V' = \bigsqcup_{i+j \text{ even}} V_{(i,j)} \subseteq \widetilde{M}, \quad V'' = \bigsqcup_{i+j \text{ odd}} V_{(i,j)} \subseteq \widetilde{M},$$

and observe that $V' \cap V'' = \widetilde{\mathcal{S}}$, $V' \cup V'' = \widetilde{M}$. Also observe that we have an obvious homotopy equivalence between $\widetilde{M} \setminus \widetilde{\mathcal{S}}$ and the disjoint union $V' \sqcup V''$.

Also the covering \widetilde{Y} of the figure-eight graph Y admits a similar decomposition. Putting together the Mayer–Vietoris sequences relative to these decompositions, which are preserved by the map $f: \widetilde{M} \rightarrow \widetilde{Y}$ introduced above, we get the commutative diagram

$$\begin{array}{ccccccc} H_1(V' \cap V'') & \xrightarrow{\theta} & H_1(\widetilde{M} \setminus \widetilde{\mathcal{S}}) & \xrightarrow{i_*} & H_1(\widetilde{M}) = [G, G] & \longrightarrow & H_0(\widetilde{\mathcal{S}}) \cong \Lambda^2, \\ & & \downarrow & & \downarrow \tilde{f}_* & & \downarrow \cong \\ 0 & \longrightarrow & H_1(\widetilde{Y}) = F_2/[F_2, F_2] & \longrightarrow & \Lambda^2 & & \end{array}$$

where rows are exact, and the last vertical arrow is an isomorphism. By chasing the diagram, it is now easy to show that $i_*(H_1(\widetilde{M} \setminus \widetilde{\mathcal{S}})) = \ker \tilde{f}_*$, whence the conclusion. \square

Remark 8.14. The last diagram in the proof of Lemma 8.13 shows that $T(M)$ is isomorphic to the quotient of $H_1(\widetilde{M} \setminus \widetilde{\mathcal{S}})$ by the image of $H_1(V' \cap V'')$ via the map θ . By definition, if $\widetilde{\mathcal{S}}$ is

the component of $\tilde{\mathcal{S}}$ separating $V_{(i',j')} \subseteq V'$ and $V_{(i'',j'')} \subseteq V''$, then θ maps every $\alpha \in H_1(\tilde{\mathcal{S}})$ into the difference $\theta'(\alpha) - \theta''(\alpha)$, where θ' (resp. θ'') is induced by the inclusion of $\tilde{\mathcal{S}}$ into V' (resp. into V''). This remark will prove useful in Theorem 8.16 for explicitly constructing a presentation of $T(M)$.

From now on, we denote by W a regular neighbourhood of the set $H \cup S_1 \cup S_2$. Henceforth, we also make the

Standing assumption: The cut system \mathcal{S} is ∂ -connected.

We stress that this assumption plays a fundamental rôle in several arguments below.

Lemma 8.15. *The inclusion $S_1 \cup S_2 \hookrightarrow W$ induces an isomorphism*

$$H_1(S_1) \oplus H_1(S_2) \cong H_1(W).$$

Proof. The decomposition $W = H \cup (S_1 \cup S_2)$ provides the Mayer–Vietoris sequence

$$H_1(\partial S_1 \cup \partial S_2) \longrightarrow H_1(S_1 \cup S_2) \oplus H_1(H) \longrightarrow H_1(W) \longrightarrow H_0(\partial S_1 \cup \partial S_2)$$

It is readily seen that our assumptions on ∂S_i , $i = 1, 2$, imply that the last arrow is the zero map, while the first one has exactly $H_1(H)$ as image. This implies the conclusion. \square

Let now g_i be the genus of S_i , and let $\beta_1^i, \dots, \beta_{2g_i}^i$ be a basis of $H_1(S_i)$. Observe that $V = S^3 \setminus W$, and let us define $(\beta_i^j)^+ \in H_1(V)$ (resp. $(\beta_i^j)^- \in H_1(V)$) as the element obtained by “pushing” β_i^j on the positive (resp. negative) side of S_j into V .

We define the Seifert matrices $A^{11}, A^{12}, A^{21}, A^{22}$ as follows:

$$(A^{hk})_{ij} = \text{lk}((\beta_i^h)^-, \beta_j^k), \quad h, k \in \{1, 2\}, \quad i = 1, \dots, 2g_h, \quad j = 1, \dots, 2g_k,$$

where lk is the linking number in S^3 . Note that by the symmetry properties of the linking number we have ${}^t A^{12} = A^{21}$.

Let us fix the identification $\Lambda \cong \mathbb{Z}[t_1^{\pm 1}, t_2^{\pm 1}]$ which carries the element $k_i \in K$ dual to S_i to the variable t_i , $i = 1, 2$.

Lemma 8.16. *The module $T(M)$ admits the presentation matrix*

$$B = \begin{pmatrix} {}^t A^{11} - t_1 A^{11} & (1 - t_1) A^{12} \\ (1 - t_2) A^{21} & {}^t A^{22} - t_2 A^{22} \end{pmatrix}.$$

Proof. Since $V = S^3 \setminus W$, by Lemma 8.15 (and Alexander duality) there exists a basis $\gamma_1^1, \dots, \gamma_{2g_1}^1, \gamma_1^2, \dots, \gamma_{2g_2}^2$ of $H_1(V)$ which is dual to the β_i^j 's, in the sense that $\text{lk}(\beta_i^j, \gamma_h^k) = \delta_{ih} \delta_{jk}$, where lk is the linking number in S^3 . Of course, the γ_i^j 's generate $H_1(\tilde{M} \setminus \tilde{\mathcal{S}})$ as a Λ -module. By Remark 8.14, in order to obtain a presentation of $T(M)$ we have now to add the relations

$$t_i \cdot (\beta_j^i)^+ = (\beta_j^i)^-,$$

written in terms of the γ_j^i 's. The conclusion follows. \square

The following Corollary, together with Lemma 8.6, achieves the proof of the last point of Proposition 8.7.

Corollary 8.17. *Given a ∂ -connected cut system $\mathcal{S} = \{S_1, S_2\}$ of M , and fixing the identification of Λ with $\mathbb{Z}[t_1^{\pm 1}, t_2^{\pm 1}]$ associated to \mathcal{S} , the principal ideal $E_2(M)$ is generated by a polynomial $\Delta_2(M)$ satisfying the condition:*

$$\Delta_2(M)(t_1^{-1}, t_2^{-1}) = t_1^{-m} t_2^{-n} \Delta_2(M)(t_1, t_2),$$

where m, n are even.

Proof. Let B be the matrix described in the statement of Lemma 8.16, and denote by B^- the matrix obtained by replacing in B every occurrence of t_i with t_i^{-1} , $i = 1, 2$. By Lemma 8.16 we have $\Delta_2(M)(t_1, t_2) = \det B$, $\Delta_2(M)(t_1^{-1}, t_2^{-1}) = \det B^-$. Moreover, B can be obtained from B^- by performing the following operations: multiplication of the first $2g_1$ rows by t_1 ; multiplication of the last $2g_2$ rows by t_2 ; transposition; multiplication of the whole matrix by -1 (this operation does not change the determinant, since the matrix has even order); multiplication of the first $2g_1$ columns by $(1 - t_2)$; multiplication of the last $2g_2$ columns by $(1 - t_1)$; division of the first $2g_1$ rows by $(1 - t_2)$; division of the last $2g_2$ rows by $(1 - t_1)$. It readily follows that

$$\Delta_2(M)(t_1^{-1}, t_2^{-1}) = t_1^{-2g_1} t_2^{-2g_2} \Delta_2(M)(t_1, t_2).$$

□

The proof of Proposition 8.7 is now complete.

8.13. The elementary ideals associated to the graphs $\Gamma_1(p)$. For every odd prime p , let us set $M_1(p) = C(H_1(p))$, where $\Gamma_1(p)$ is the graph described in Figure 12. This Subsection is devoted to the proof of the following:

Proposition 8.18. *For every odd prime p , the ideal $E_2(M_1(p))$ is principal, but not symmetric. Therefore, by Corollary 8.17, the $M_1(p)$ does not admit any $(M \rightarrow W)$ -boundary-preserving-map, or equivalently it does not admit any ∂ -connected cut system. Hence $H_1(p)$ is $(3)_S$ -knotted.*

Proof. We begin by providing a presentation of the fundamental group of $M_1(p)$, via the well-known Wirtinger's procedure. So, let us consider the diagram \mathcal{D} of $\Gamma_1(p)$ described in Figure 8.13, and let us denote by a_i (resp. b_i, c_i, d_i) the element of the fundamental group represented by a loop based above the plane of the diagram and positively encircling the arc labelled by a_i (resp. b_i, c_i, d_i) (recall that an arc is an embedded curve in \mathcal{D} having as endpoints either an under-crossing or a vertex of $\Gamma_1(p)$).

Let us set $r = (p + 1)/2$. The group $G = \pi_1(M_1(p))$ has a presentation with generators a_i, b_j, c_i, d_i , $i = 1, \dots, r$, $j = 1, \dots, r - 1$, and relations arising at every crossing and every vertex of \mathcal{D} . More precisely, the two vertices determine the relations $c_1 c_r^{-1} a_r$ and $d_1 d_r^{-1} a_1$, while looking at the crossings we obtain the relations

$$(8) \quad c_i b_i c_i^{-1} a_i^{-1}, \quad b_i c_i b_i^{-1} c_{i+1}^{-1}, \quad b_i d_i b_i^{-1} d_{i+1}^{-1}, \quad d_{i+1} b_i d_{i+1}^{-1} a_{i+1}^{-1},$$

for $i = 1, \dots, r - 1$. Let us denote by F_{4r-1} the free group generated by the symbols a_i, b_j, c_i, d_i , $i = 1, \dots, r$, $j = 1, \dots, r - 1$, and by $j: F_{4r-1} \rightarrow G$ and $k: G \rightarrow G/[G, G]$ the natural projections. Then we have $G/[G, G] \cong H_1(M_1(p)) \cong \mathbb{Z}^2$. Moreover, it is readily seen that we may choose generators t, s of $H_1(M_1(p))$ in such a way that $k(j(c_i)) = t$, $k(j(d_i)) = s$ and $k(j(a_i)) = k(j(b_i)) = 1$ for every i (we denote here by 1 the identity of $H_1(M_1(p))$, which is considered as a multiplicative group). By Theorem 8.1, the module $A(G) = A(M_1(p))$ admits a presentation with generators $\bar{a}_i, \bar{b}_j, \bar{c}_i, \bar{d}_i$, $i = 1, \dots, r$, $j = 1, \dots, r - 1$, and relations which can be deduced by from the relations defining G via Fox differential calculus.

Now, if x, y, z belong to the fixed set of generators of F_{4r-1} , then we have

$$\begin{aligned} k(j(\partial_x x y x^{-1} z^{-1})) &= 1 - k(j(y)), \\ k(j(\partial_y x y x^{-1} z^{-1})) &= k(j(x)), \\ k(j(\partial_z x y x^{-1} z^{-1})) &= -k(j(y))k(j(z))^{-1}, \end{aligned}$$

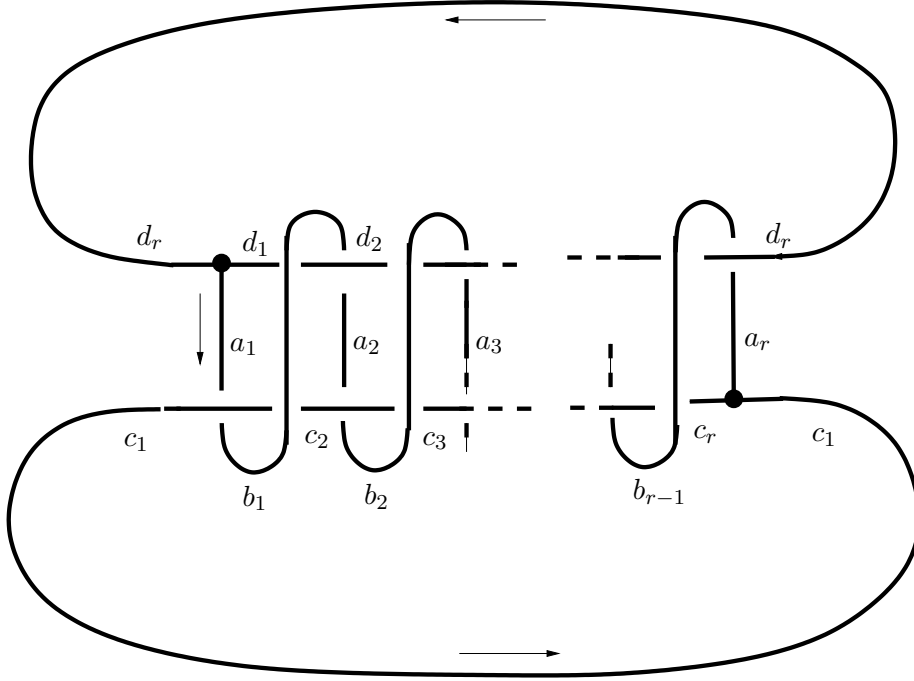
FIGURE 27. Notation for a Wirtinger presentation of $\pi_1(M_1(p))$.

so the relations (8) induce the following relations for $A(G)$:

$$(9) \quad \bar{b}_i = t^{-1}\bar{a}_i, \quad \bar{c}_{i+1} = (1-t)\bar{b}_i + \bar{c}_i, \quad \bar{d}_{i+1} = (1-s)\bar{b}_i + \bar{d}_i, \quad \bar{a}_{i+1} = s\bar{b}_i,$$

where $i = 1, \dots, r-1$. Moreover, the relations arising from the vertices of \mathcal{D} give rise to the relations

$$(10) \quad \bar{c}_r - \bar{c}_1 = \bar{a}_r, \quad \bar{d}_r - \bar{d}_1 = \bar{a}_1.$$

It is readily seen that equations (9) imply that

$$(11) \quad \begin{aligned} \bar{a}_i &= (st^{-1})^{i-1}\bar{a}_1, & i &= 1, \dots, r, \\ \bar{b}_i &= t^{-1}(st^{-1})^{i-1}\bar{a}_1, & i &= 1, \dots, r-1, \\ \bar{c}_i &= \bar{c}_1 + (1-t)t^{-1}\left(\sum_{j=0}^{i-2}(st^{-1})^j\right)\bar{a}_1, & i &= 1, \dots, r, \\ \bar{d}_i &= \bar{d}_1 + (1-s)t^{-1}\left(\sum_{j=0}^{i-2}(st^{-1})^j\right)\bar{a}_1, & i &= 1, \dots, r. \end{aligned}$$

Putting together the relations (11) and (9), we obtain that a presentation for $A(G)$ is given by the generators $\bar{a}_1, \bar{c}_1, \bar{d}_1$ with relations

$$\left((1-t)t^{-1} \left(\sum_{j=0}^{r-2} (st^{-1})^j \right) - (st^{-1})^{r-1} \right) \bar{a}_1 = 0,$$

$$\left((1-s)t^{-1} \left(\sum_{j=0}^{r-2} (st^{-1})^j \right) - 1 \right) \bar{a}_1 = 0.$$

As expected (since every fixed relation of a Wirtinger presentation is a consequence of the other ones), these last two conditions are equivalent, and

$$A(G) = \Lambda^2 \oplus \Lambda/(f(s, t)), \quad f(s, t) = (1 - s)t^{-1} \left(\sum_{j=0}^{r-2} (st^{-1})^j \right) - 1.$$

By Lemma 8.2, we have $E_2(A(G)) = E_0(\Lambda/(f(s, t))) = (f(s, t))$, so in order to conclude we only have to show that the ideal $(f(s, t))$ is not symmetric, *i.e.* that the ideals generated by $f(s, t)$ and by $f(s^{-1}, t^{-1})$ do not coincide.

However, it is readily seen that every non-null principal ideal of $\Lambda = \mathbb{Z}[s^{\pm 1}, t^{\pm 1}]$ admits a preferred generator which lies in $\mathbb{Z}[s, t]$ and is not divisible (in $\mathbb{Z}[s, t]$) by s or t . Such a generator is unique up to sign. Now, the preferred generators of $(f(s, t))$ and of $(f(s^{-1}, t^{-1}))$ are respectively

$$f_1(s, t) = t^{r-1}f(s, t) = (1 - s) \left(\sum_{j=0}^{r-2} s^j t^{r-j-2} \right) - t^{r-1},$$

$$f_2(s, t) = s^{r-1}f(s^{-1}, t^{-1}) = (s - 1)t \left(\sum_{j=0}^{r-2} s^j t^{r-j-2} \right) + s^{r-1}.$$

Since $f_1(s, t) \neq \pm f_2(s, t)$, the proof of point (1) of Proposition 8.18 is complete. \square

8.14. The elementary ideals of the Kinoshita graph complement. This Subsection is devoted to the proof of the following:

Proposition 8.19. *The elementary ideal $E_2(M_K)$ of Kinoshita's manifold M_K is not principal. Therefore, $\text{cut}(M_K) = 1$.*

Proof. As showed in [49], the manifold M_K admits an ideal triangulation with two tetrahedra. By analyzing the combinatorial structure of such a triangulation it is immediate to write down the following presentation for the fundamental group G of M_K (such a presentation is much simpler than any Wirtinger presentation associated to a diagram of K):

$$\langle x_1, x_2, x_3 \mid x_1 x_2 x_1^{-1} x_3 x_1 x_3^{-1} x_2 x_3 x_2^{-1} \rangle.$$

If we denote by r the above relation, then we have

$$\begin{aligned} \partial_1 r &= 1 - x_1 x_2 x_1^{-1} + x_1 x_2 x_1^{-1} x_3, \\ \partial_2 r &= x_1 + x_1 x_2 x_1^{-1} x_3 x_1 x_3^{-1} - x_1 x_2 x_1^{-1} x_3 x_1 x_3^{-1} x_2 x_3 x_2^{-1}, \\ \partial_3 r &= x_1 x_2 x_1^{-1} - x_1 x_2 x_1^{-1} x_3 x_1 x_3^{-1} + x_1 x_2 x_1^{-1} x_3 x_1 x_3^{-1} x_2. \end{aligned}$$

Moreover, if $j: F(x_1, x_2, x_3) \rightarrow G$ and $k: G \rightarrow G/[G, G]$ are the natural projections, then we have $G/[G, G] \cong \langle t_1, t_2 \rangle$, where $t_1 = k(j(x_1))$, $t_2 = k(j(x_2))$ and $k(j(x_3)) = t_1^{-1} t_2^{-1}$. Therefore

$$k(j(\partial_1 r)) = 1 + t_1^{-1} - t_2, \quad k(j(\partial_2 r)) = -1 + t_1 + t_1 t_2, \quad k(j(\partial_3 r)) = t_2(1 - t_1 + t_1 t_2).$$

Let us now compute $E_2(M_K)$. Let $p_i = k(j(\partial_i r))$, $i = 1, 2, 3$, and observe that $E_2(M_K) = (p_1, p_2, p_3)$. Since t_1, t_2 are invertible in Λ , if $p'_1 = t_1 p_1 = 1 + t_1 - t_1 t_2$, $p'_3 = t_2^{-1} p_3 = 1 - t_1 + t_1 t_2$, then $E_2(M_K) = (p'_1, p_2, p'_3)$. Moreover, we have $2 = p'_1 + p'_3 \in E_2(M_K)$, and $p_2 = p'_1 + (t_1 t_2 - 1) \cdot 2$, so

$$E_2(M_K) = (2, p'_1) = (2, 1 + t_1 - t_1 t_2).$$

Since 2 is irreducible in Λ and does not divide $1 + t_1 - t_1 t_2$, we have $\Delta_2(M_K) = 1$. Therefore, if $E_2(M_K)$ were principal, there would exist Laurent polynomials $q_1, q_2 \in \mathbb{Z}[t_1^{\pm 1}, t_2^{\pm 1}]$ such that

$$(1 + t_1 - t_1 t_2) \cdot q_1(t_1, t_2) + 2q_2(t_1, t_2) = 1,$$

whence

$$(1 + t_1 + t_1 t_2) \cdot \bar{q}_1(t_1, t_2) = 1 \text{ in } \mathbb{Z}_2[t_1^{\pm 1}, t_2^{\pm 1}]$$

for a Laurent polynomial $\bar{q}_1 \in \mathbb{Z}_2[t_1^{\pm 1}, t_2^{\pm 1}]$. Since $(1 + t_1 + t_1 t_2)$ is not invertible in $\mathbb{Z}_2[t_1^{\pm 1}, t_2^{\pm 1}]$, this gives a contradiction, hence $E_2(M_K)$ is not principal. Then it follows from Proposition 8.7 that the cut number of M_K is not equal to 2. \square

8.15. Infinitely many $(4)_L$ -knotted handlebodies. We now show how starting from a $M = C(H)$ such that $\text{cut}(M) = 1$ (like M_K) we can construct infinitely many other examples having cut number equal to 1. Let Γ be a spine of H . Let $B \subseteq S^3$ be a 3-ball whose boundary intersects transversely Γ at two regular points, and such that (B, ℓ) , $\ell := B \cap \Gamma$, is an unknotted 1–1 tangle. We call such an ℓ an *untangled arc* of Γ . We now replace (B, ℓ) by a 1–1 tangle (B, T) such that T and ℓ have the same end–points, thus obtaining a new graph Γ' . If K is the knot obtained as the closure of (B, T) in S^3 , then we denote the spatial graph Γ' by the symbol $\Gamma \#_{\ell} K$. If orientations on K and on Γ are not specified, then there are nonequivalent ways of performing the “sum” $\Gamma \#_{\ell} K$, but to our purposes this is not relevant.

Lemma 8.20. *Suppose that $\text{crk}(\pi_1(S^3 \setminus \Gamma)) = 1$. Then, for every sum $\Gamma \#_{\ell} K$ as above, we have $\text{crk}(\pi_1(S^3 \setminus (\Gamma \#_{\ell} K))) = 1$.*

Proof. Let us set $G_{\Gamma} = \pi_1(S^3 \setminus \Gamma)$, $G_K = \pi_1(S^3 \setminus K)$, $G_{\Gamma \#_{\ell} K} = \pi_1(S^3 \setminus (\Gamma \#_{\ell} K))$, and let $\psi: G_{\Gamma \#_{\ell} K} \rightarrow F_2$ be a homomorphism. We will show that ψ is not surjective.

Let (B, ℓ) and (B, T) be the tangles involved in the construction of $\Gamma \#_{\ell} K$, as above. Then, the set $\Omega_1 = S^3 \setminus (\Gamma \cup B)$ is a deformation retract of $S^3 \setminus \Gamma$, and intersects a regular neighbourhood Ω_2 of $B \setminus T$ in an annulus. Also observe that $\Omega_1 \cup \Omega_2 = S^3 \setminus (\Gamma \#_{\ell} K)$, so we have the following commutative diagram

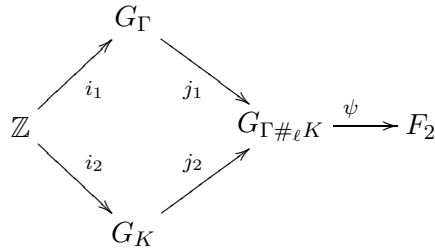

where i_2 maps a generator of \mathbb{Z} onto the class of a meridian of $S^3 \setminus K$. Since G_K has corank one and every subgroup of a free group is free, the group $\psi(j_2(G_K))$ is cyclic (possibly trivial), whence abelian. This implies that $\psi \circ j_2$ factors through $H_1(S^3 \setminus K) \cong \mathbb{Z}$. Since $i_2(\mathbb{Z}) < \pi_1(G_K)$ isomorphically maps onto $H_1(S^3 \setminus K) = G_K/[G_K, G_K]$, this implies that

$$(12) \quad \psi(j_2(G_K)) = \psi(j_2(i_2(\mathbb{Z}))) = \psi(j_1(i_1(\mathbb{Z}))) < \psi(j_1(G_{\Gamma})).$$

By Van Kampen’s Theorem, the group $G_{\Gamma \#_{\ell} K}$ is generated by $j_1(G_{\Gamma}) \cup j_2(G_K)$. Together with (12), this implies that $\psi(G_{\Gamma \#_{\ell} K}) = \psi_1(G_{\Gamma})$. But $\psi_1(G_{\Gamma})$ cannot be the whole F_2 since the corank of $\psi_1(G_{\Gamma})$ is one, so ψ is not surjective. \square

Now, let H_1, \dots, H_n be non–isotopic handlebodies whose complements in S^3 have cut number equal to 1. We show how to construct inductively a further handlebody H_{n+1} such that $\text{cut}(C(H_{n+1})) = 1$ and $C(H_{n+1})$ is not homeomorphic to $C(H_i)$, $i = 1, \dots, n$ (in particular, H_{n+1} is not isotopic to H_i , $i = 1, \dots, n$). Starting for example from M_K , this procedure provides the desired infinite family of examples with cut number equal to 1, thus concluding the proof of Theorem 3.13.

So, let Γ be a (hc)–spine of H_n , having K_1, K_2 as constituent knots. Let ℓ be an untangled sub-arc of K_1 which does not contain any vertex of Γ . Let also N be the maximum of the

ranks of the fundamental groups of $S^3 \setminus H_1, \dots, S^3 \setminus H_n$ (recall that the rank of a group is the minimal number of generators in any presentation of the group), and take a knot K_3 which is the sum of $N + 1$ non-trivial knots. Define H_{n+1} as the regular neighbourhood of $\Gamma \#_\ell K_3$. By Lemma 8.20, the complement of H_{n+1} has cut number equal to 1. Moreover, by compressing $S^3 \setminus H_{n+1}$ along the meridian disk of H_{n+1} dual to K_2 , we obtain $S^3 \setminus N(K_1 \# K_3)$. This readily implies that the rank of $\pi_1(S^3 \setminus H_{n+1})$ is not smaller than the rank of $\pi_1(S^3 \setminus N(K_1 \# K_3))$. But $K_1 \# K_3$ is the sum of at least $N + 1$ non-trivial knots, so $\text{rk } \pi_1(S^3 \setminus N(K_1 \# K_3)) \geq N + 1$ by [55]. In particular, $\pi_1(S^3 \setminus H_{n+1})$ is not isomorphic to $\pi_1(S^3 \setminus H_i)$ for every $i = 1, \dots, n$.

The proof of Theorem 3.13 is now complete.

9. PERSPECTIVES

Let us summarize what we have achieved so far. In Section 3 we asked some questions concerning the relations that hold among extrinsic and intrinsic definitions of knotting for spatial handlebodies. The results proved in our paper provide a quite clear picture of the situation. However, two questions still remain open (as usual, $M = \mathbb{C}(H)$):

- (a) Does the existence of a ∂_R -connected cut system for M imply that H is not $(3)_L$ -knotted?
- (b) Does the existence of a cut system for M imply that H is not $(4)_L$ -knotted?

Taking into account Remark 7.4, we expect that, in order to answer these questions, one should probably invoke very deep results. We get a potentially easier weaker version of these questions by allowing us to work *up to reimbedding* of M .

We observe that the quandle obstructions we have constructed have proved to be sufficiently effective for producing some “ad hoc” examples pertinent to our discussion. On the other hand, they are by themselves very weak, and the quandle invariants machinery is potentially much more powerful. For example, the basic dihedral quandle invariants we have used are not able to distinguish the Kinoshita’s M_K from the unknotted handlebody. In [24] this is done by means of more sophisticated “twisted” quandle invariants that involve the tetrahedral quandle and a suitable *quandle cocycle* on it. Then the following is a natural challenge in order to test the performances of quandle invariants theory:

Is the whole program outlined in the present paper achievable only by means of sufficiently sophisticated instances of quandle invariants (recovering by the way also the information derived via the analysis handlebody patterns and the Alexander module obstructions)?

We conclude with a short outline about how to extend the above discussion to H of *arbitrary genus* $g \geq 2$.

- The instances of knotting of H can be straightforwardly generalized in terms of multi-hand-cuff spines, that are spines Γ containing a maximal 3-valent open sub-tree (playing the rôle of the isthmus) and carrying a g -component constituent link L_Γ .
- The definitions concerning the cut systems of M are formally the same, provided that they are formed by g disjoint surfaces.
- A weaker version of Proposition 4.3 holds, depending on the weaker conclusions of Theorem 4 in [41], when $g > 2$.
- The use of the quandle obstructions can be adapted, obtaining the same conclusions of Proposition 5.1.
- The definitions and the results of Section 6 can be adapted to the general case (but observe that the analysis of the longitudes is more complicated when $g > 2$).

- The discussion about the Alexander module obstructions extends, by realizing that the relevant elementary ideal is now $E_g(M)$. In this way we get results analogous to Theorem 3.13 (implying that every instance of knotting is non-empty) and Proposition 8.18 (implying that there exist handlebodies with a trivial constituent link which do not admit ∂ -connected cut-systems).
- The conclusion of Theorem 3.11 holds in general, and the proof essentially makes use of the full Poincaré conjecture.
- So far we have extended the discussion focusing on the alternative for M of *being or not of maximal cut number* equal to g . A more demanding problem (of the same type) would arise by filtering the M 's via the cut number values, pointing out a corresponding filtering of the instances of knotting of H .

REFERENCES

- [1] R. Benedetti, R. Frigerio, R. Ghiloni, *The topology of Helmholtz domains*, arXiv:1001.4418 (2010).
- [2] P. Bellis, *Homology boundary links, patterns, and Seifert forms*, Thesis (Ph.D.) Rice University, 1996.
- [3] P. Bellis, *Realizing homology boundary links with arbitrary patterns*, Trans. Amer. Math. Soc. **350** (1998), 87–100.
- [4] R.H. Bing, *Mapping a 3-sphere onto a homotopy 3-sphere*, Topology Seminar, Wisconsin, 1965, Annals of Mathematics Studies, no. 60, Princeton, 1966, 89–99.
- [5] J.S. Birman, H.M. Hilden, *Heegaard splittings of branched coverings of S^3* , Trans. Amer. Math. Soc. **213** (1975), 315–352.
- [6] J. Birman, *On the equivalence of Heegaard splittings of closed, orientable 3-manifolds*, in “Knots, Groups and 3-manifolds”, Annals of Math. Studies **84** (1975).
- [7] J. Cantarella, D. DeTurck, H. Gluck, *Vector Calculus and the Topology of Domains in 3-Space*, Amer. Math. Monthly **109** (2002), 409–442.
- [8] S.Cho, D. McCullough, *The tree of knot tunnels*, Geom. Topol. **13** (2009), 769–815.
- [9] D. Cimasoni, *Studying the multivariable Alexander polynomial by means of Seifert surfaces*, Bol. Soc. Mat. Mexicana (3) **10** (2004), Special Issue, 107–115.
- [10] T. D. Cochran, J. Levine, *Homology boundary links and the Andrews–Curtis conjecture*, Topology **30** (1991), 231–239.
- [11] T. D. Cochran, K. E. Orr, *Not all links are concordant to boundary links*, Bull. Amer. Math. Soc. **23** (1990), 99–106.
- [12] T. D. Cochran, K. E. Orr, *Not all links are concordant to boundary links*, Ann. of Math. (2) **138** (1993), 519–554.
- [13] M. Cohen, W. Metzler, A. Zimmermann, *What does a basis of $F(a, b)$ look like?* Math. Ann. **257** (1981), 435–445.
- [14] R. H. Fox, *The Imbedding of Polyhedra in 3-Space*, Ann. Math. **49** (1948), 462–470.
- [15] R. H. Fox, *Free differential Calculus*, Ann. Math. **57** (1953) 547–560.
- [16] R. Frigerio, B. Martelli, C. Petronio, *Complexity and Heegaard genus of an infinite class of compact 3-manifolds*, Pacific J. Math. **210** (2003), 283–297.
- [17] S.M. Ghuman, L.M. Granda, C.M. Tsau, *Dehn surgery on singular knots*, J. Knot Theory Ramifications **18** (2009), 547–560.
- [18] C.McA. Gordon, *On primitive sets of loops in the boundary of a handlebody*, Topology Appl. **27** (1987), no. 3, 285–299.
- [19] M. A. Gutierrez, *Polynomial invariants of boundary links*, Rev. Columbiana Mat. VIII (1974), 97–109.
- [20] J. Hillmann, *Algebraic invariants of links*, Series on Knots and Everything, 32. World Scientific Publishing Co., Inc., River Edge, NJ, 2002.
- [21] J.A. Hillman, *Alexander Ideals of links*, LNM 895, Springer, 1981.
- [22] J.A. Hillman, *Longitudes of a Link and principality of an Alexander ideal*, Proc. Amer. Math. Soc. **72** (1978), 370–374.
- [23] A. Ishii, *Moves and invariants for knotted handlebodies*, Algebraic and Geometric Topology **8** (2008), 1403–1418.
- [24] A. Ishii, M. Iwakiri, *Quandle cocycle invariants for spatial graphs and knotted handlebodies*, to appear in Canad. J. Math.

- [25] W. Jaco, *Three-manifolds with fundamental group a free product*, Bull. Amer. Math. Soc. **75** (1969), 972–977.
- [26] W. Jaco, *Nonretractable cubes-with-holes*, Michigan Math. J. **18** (1971), 193–201.
- [27] L. H. Kauffman, *Invariants of Graphs in 3-space*, Trans. Amer. Math. Soc. **311** (1989), 697–710.
- [28] S. Kinoshita, *On elementary ideals of polyhedra in the 3-sphere*, Pacific J. Math. **42** (1972), 89–98.
- [29] S. Kojima, Y. Miyamoto, *The smallest hyperbolic 3-manifolds with totally geodesic boundary*, J. Differential Geom. **34** (1991), 175–192.
- [30] H. W. Lambert, *Mapping cubes with holes onto cubes with handles*, Illinois J. Math. **13** (1969), 606–615.
- [31] J.H. Lee, G.T. Gin, *Two tunnels of a tunnel numer one link*, Proceedings of the East Asian school of knots, links and related topics, Seoul, Korea, 2004.
- [32] R. Lickorish, *An introduction to knot theory*, Graduate Texts in Mathematics **175**, Springer-Verlag, New York, 1997.
- [33] G. S. Makanin, *Equations in a free group*, Izv. Akad. Nauk SSSR Ser. Mat. **46** (1982), no. 6, 1199–1273.
- [34] W. Magnus, A. Karras, B. Solitar, *Combinatorial group theory: presentations in terms of generators and relators*, Wiley (Interscience) 1966.
- [35] J. Nielsen, *Die Isomorphismen der allgemeinen, unendlichen Gruppe mit zwei Erzeugenden*, Math. Ann. **78** (1917), 385–397.
- [36] R. P. Osborne, H. Zieschang, *Primitives in the free group on two generators*, Invent. Math. **63** (1981), 17–24.
- [37] J.W. Morgan, *The Smith conjecture* (New York, 1979), Pure Appl. Math. **112**, Academic Press, Orlando, FL, 1984.
- [38] C.D. Papakyriakopoulos, *On Dehn’s lemma and the asphericity of knots*, Ann. Math. **66** (1957), 1–26.
- [39] M. Scharlemann, A. Thompson, *Detecting unknotted graphs in 3-spaces*, J. Differential Geometry **34** (1991), 539–560.
- [40] M. Scharlemann, A. Thompson, *Thin position and Heegaard splittings of the 3-sphere*, J. Differential Geometry **39** (1994), 343–357.
- [41] M. Scharlemann, A. Thompson, *Surfaces, submanifolds, and aligned Fox reimbedding in non-Haken 3-manifolds*, Proc. Amer. Math. Soc. **133** (2004), 1573–1580.
- [42] M. Scharlemann, *Refilling meridians in a genus 2 handlebody complement*, Geometry and Topology Monograph **14** (2008), 451–475.
- [43] N. Smythe, *Boundary links*, in Topology Seminars, Ann. Math. Studies 60, ed. R.H. Bing, Princeton Univ. Press 1965.
- [44] J. R. Stallings, *Homology and central series of groups*, J. Algebra **2** (1965), 170–181.
- [45] J. R. Stallings, *Problems about free quotients of groups*, Geometric group theory (Columbus, OH, 1992), 165–182, Ohio State Univ. Math. Res. Inst. Publ. 3, de Gruyter, Berlin, 1995.
- [46] S. Suzuki, *Alexander ideals of graphs in the 3-sphere*, Tokyo J. Math. **7** (1984), no. 1, 233–247.
- [47] S. A. Taylor, *Boring split links*, Pacific J. Math. **241** (2009), no. 1, 127–167.
- [48] G. Torres, R.H. Fox, *Dual presentations of the group of a knot*, Ann. of Math. (2) **59** (1954), 211–218.
- [49] W. P. Thurston, *Three-Dimensional Geometry and Topology*, Princeton Math. Ser., vol. 35, Princeton University Press, Princeton, NJ, 1997.
- [50] L. Traldi, *The determinantal ideals of link modules, I*, Pac. J. Math. **101** (1982), 215–222.
- [51] L. Traldi, *The determinantal ideals of link modules, II*, Pac. J. Math. **109** (1983), 237–245.
- [52] Y. Tsukui, *On surfaces in 3-space*, Yokohama Math. J. **18** (1970), 93–104.
- [53] A. Ushijima, *Hyperbolic spatial graphs arising from strongly invertible knots*, Topology Appl. **139** (2004), 253–260.
- [54] F. Waldhausen, *Heegaard-Zerlegungen der 3-Sphäre*, Topology **7** (1968), 195–203.
- [55] R. Weidmann, *On the rank of amalgamated products and product knot groups*, Math. Ann. **312** (1998), no. 4, 761–771.
- [56] C. M. Weinbaum, *Partitioning a primitive word into a generating set*, Math. Ann. **181** (1969), 157–162.
E-mail address: benedett@dm.unipi.it, frigerio@dm.unipi.it