

Designing Assistive Technology for Getting More Independence for Blind People when Performing Everyday Tasks: An Auditory-Based Tool as a Case Study

Barbara Leporini
ISTI-CNR
via Moruzzi 1, 56124 Pisa, Italy
barbara.leporini@isti.cnr.it

Michele Rosellini
DICI-University of Pisa
L.go L. Lazzarino 2, Pisa, Italy
michele.rosellini@unipi.it

Nicola Forgiione
DICI-University of Pisa
L.go L. Lazzarino 2, Pisa, Italy
nicola.forgione@unipi.it

ABSTRACT

Everyday activities and tasks should in theory be easily carried by everyone, including the blind. Information and Communication Technology (ICT) has been widely used for supporting solutions. However, the solutions can be problematic for the visually impaired since familiarity with digital devices is often required. Or, indeed the procedure can be perceived as fiddly or impractical particularly for repetitive tasks due to the number/type of steps required to complete the task. This paper introduces a simple audio-based tool aimed at supporting visually-impaired people in the seemingly simple activity of checking whether the light in a room is on or off. It is an example of potential low tech devices that can be designed without the need for specific skills or knowledge by the user, and that functions in a practical way. In this context, we discuss the main issues and considerations for totally blind users in identifying whether a light is switched on. The proposed prototype is based on a simple circuit and a form of auditory feedback which informs the user whether they are switching on or off the light. Two prototypes have been designed and built for two different kinds of installation. For the subsequent second prototype, three different versions are proposed to provide a blind person with further support in easily identifying the light status at home. The new design includes enhanced auditory feedback and modifications to the dimensions. The evaluation conducted by involving various groups of end-users revealed the usefulness of the proposed tool. In addition, a survey conducted with 100 visually-impaired people reported the limitations and difficulties encountered by the blind in using existing devices. Moreover, the study revealed the interest from 94% of the participants for a potential (new) basic tool integrable with the existing lighting system.

This study gives a contribution in the ambient intelligence field by (1) showing how an auditory-based tool can be used to support totally blind people to check the lights in an autonomous and relatively simple way; (2) proposing an idea that can be exploited in other application cases that use light feedback; and (3) proposing seven potential recommendations for designing assistive technology tools and common everyday devices, based on information gathered from the online survey.

KEYWORDS

Smart home, Home Automation, Visually-impaired

1 Introduction

Full autonomy when performing everyday tasks and activities is a challenge for people with disabilities, including the visually-impaired (Jones et al. 2019; Wang and Yu 2017). Several studies have been exploring new opportunities by proposing tools, methodologies and assistive technologies (ATs) aimed at overcoming the numerous barriers (Cook&Polgar 2014; El-Basioni et al. 2014; Hersh&Johnson 2010; Mennicken et al. 2015). Web-based applications and mobile apps have been proposed to make carrying out everyday activities easier and more convenient, such as those related to Home Automation Systems (Chen et al. 2017; El-Basioni et al. 2014; Jeet et al. 2015). However, in many cases for people who cannot see, interacting with web and mobile apps can be difficult and/or require good digital skills (Buzzi et al. 2015; Carvalho et al. 2018; Damaceno et al. 2018; Power et al. 2012; Rodrigues et al. 2015; Sierra&Togores 2012). The combination of an older generation with vision-impairments (Wahl et al. 1999) may be a reason for poor familiarity with advanced technology services and apps managed in particular via smartphones and tablets (Costa et al. 2013). In addition, the current solutions are often fiddly and time-consuming due to the numerous gestures or steps required to carry out repeated everyday tasks. This is the case even for skilled users who are very familiar with apps and mobile devices. There is clearly the need for technology to be used to design a system which is simple and quick to use regardless of the users' disability or technical knowledge.

Furthermore, over the last ten years several different studies have been conducted into using technology to enhance everyday activities in the home (Amiribesheli et al. 2015; Buchmayr& Kurschl 2011; Mekuria et al. 2019). Recently,

there has been an increasing demand for developing elderly care services utilizing novel technologies, with the aim of supporting independent living. Several works are focused on monitoring activities and increasing independence at home especially for the elderly and people with special needs. Sensors are widely used for monitoring the activities as well as the user's behaviours. Collected data can be so used to propose possible solutions or for various types of services (Alemdar et al. 2017; Debes et al. 2016; Poncela et al. 2019; Tahir et al. 2019). Many solutions rely on a specific technology, such as a wi-fi connection (Xin et al. 2018) or Internet of Things (IoT)-based systems (Azimi et al. 2017) in particular for human detection and human identification for a wide range of indoor location-based services. Several studies propose also new kinds of smart home architecture based on a highly distributed environment (Plantevin et al. 2019). These approaches can be costly and require advanced technology or particular skills by the users. Our approach is aimed at proposing potential solutions which are simple to use by everyone and require no particular skills or technology and are at the same time not particularly expensive. Furthermore, most of the studies investigate smart home solutions for people with dementia (Lotfi et al. 2012), or people with motion impairments (Mtshali & Khubisa 2019). Very few studies are focused on people with sensory impairments. In this perspective, we aim to make a contribution to facilitating independence at home for visually-impaired people.

In this study we propose a tool that does not rely on mobile apps or a Home Automation System. We present an audio-based tool to be integrated into the lighting system or into light bulbs (including smart ones) in order to check the lighting status. The device is aimed at totally blind people not familiar with the technology. It is useful for those very confident with technology nonetheless as it allows them to check the status more easily, conveniently and quickly. In short, our goal is to propose an electronic tool able to (1) give feedback on the lighting status to a person who is totally blind; (2) offer a low cost solution; (3) be easily used by anyone; and (4) which can be added to smart light bulbs.

This paper is an extension of the previous work (Leporini et al. 2019): (1) a new version of the proposed tool is presented, (2) two user tests of the new prototype with 16 totally blind users are described, and (3) a survey with 100 visually-impaired users conducted for collecting information on the existing tools as well as on the potential interest for the prototype is described.

The main contribution of this study is investigating (1) if the end-users (i.e. blind people) can effectively and satisfactorily use the existing tools or mobile apps for detecting the light status, (2) a potential (new) AT tool to aid checking the light status, and (3) possible interests, preferences and features to be kept in mind by AT designers.

Specifically, in this work we propose a second version of the prototype for a new installation modality through a redesign of the shape and size, and an enhancement of the auditory feedback through variations in frequency, volume and sound length. In addition, the survey was aimed at gathering useful feedback on the potential proposed tool.

The content is organized as follows: the next section reports the motivation and issues encountered by people who are totally blind when they have to check the lighting status; section 3 introduces the motivating scenarios and methodology used in this study; section 4 describes the proposed solutions by introducing the first version of the audio-based prototype. Section 5 presents a second (new) version of the proposed prototype. Section 6 reports the results of the survey conducted with 100 visually-impaired people, and section 7 discusses all the results. Section 8 reports a tentative proposal for some potential recommendations for ATs designers. The conclusions end the paper.

2 Motivation and issues

People who are totally blind could be interested in performing several everyday tasks and activities autonomously at home (Jones et al. 2019; Leporini & Buzzi 2018; Wahl et al. 1999; Yuan et al. 2017). These include checking their home systems such as the heating, lighting and security systems. Several digital apps and tools have been created and are available on the market to support visually-impaired people in performing these activities. For instance, tools such as an audible light sensor (Microsoft 2020) or talking colour detector (RNIB 2020) are two examples of existing commercial hardware devices specifically designed for people who are blind. However, they still have many limitations when carrying out certain activities, and their effectiveness can be influenced by the users' lack of familiarity with using technological devices. Furthermore, the commercial tools are often too expensive or impractical for use by everyone and/or in certain contexts.

Leporini&Buzzi (2018) collected expectations and preferences from 42 visually-impaired people. Through an on-line questionnaire and semi-structured interviews, comments and suggestions by the users were gathered. The results highlighted a wide interest in Home Automation, but at the same time also the main difficulties and concerns about being able to use it effectively. 81% of the users interviewed declared a particular interest in being able to use the lighting system easily. More specifically, people who are totally blind wish to control the light status (on/off) autonomously, especially when they live alone or are temporarily alone. To check the lighting status, people can use specific tools or mobile apps based on a phone camera or light sensor (e.g. pointing at the ceiling) which emit a higher or lower sound depending on the light's intensity. Examples are Light Detector (EveryWare Technologies 2020), Seeing AI (Microsoft 2020) and Seeing Assistant (Transition Technologies 2020) apps and light probes and detectors

(Living made easy 2020). However, some limitations and concerns were also expressed: (1) Specific assistive portable devices (a) are relatively expensive and (b) need to be always to hand; (2) specific mobile apps require (a) a smartphone always to hand, (b) user interfaces effectively accessible, and (c) a confident use of touch-screen interaction.

Home Automation for remote control is certainly a good solution for those who are familiar with using smartphones and apps. However, technology should offer opportunities also to those who do not particularly like new interaction paradigms or are not skilled in using advanced services. Furthermore, smart home design should take into account all typologies of users, especially those who have special needs or some impairments. Unfortunately, most of the smart home designs are for non-disabled people, only a few applications of home appliance automation are designed for the disabled (Chen et al. 2017). Some studies have investigated lighting systems handled by people with disabilities. For instance, in (Freeman et al. 2016) the control of the lighting system is for those who have residual vision. The work (Jeet et al. 2015) proposes a solution based on voice control, but the commands to use are usually aimed at switching on/off the lights, but are not designed to check simply the status, which may be a useful activity for those who cannot see. In addition, solutions like this one require a home automation system as well as always having an internet connection activated. However, for repetitive everyday tasks, solutions based on simple interaction should be encouraged. Our proposed device requires a simple interaction, can be installed in each room and offers a first feedback level with no other device to hand. This can help both skilled users, and those with no or a limited familiarity with technology. Besides, it works without the need for an internet connection.

3 Adopted approach

In this section, we describe the motivations for our study, which stem from the user context and issues encountered by visually-impaired people in checking the status of the lights. Next, the approach as well as the main features of our solution are introduced.

3.1 Motivating scenarios

Being able to identify the status of the lights in a very simple and fast way can be very useful for totally blind people in various situations. In the following, four possible scenarios are described. Specifically, these scenarios emphasize those situations in which using particular devices or apps may present some limitations or certain inconveniences for the blind person in a specific context.

Scenario 1. Alan is a totally blind teen-ager. It is Saturday evening and he is alone at home since his family has gone out. His friends are coming, they just rang the doorbell. It is the evening, so the lights at the entrance and in the living rooms should be on for his guests. Did his family leave any lights on before they went out? Alan should quickly check to see if they are on or off. He could do it using the assistive light detector, but he doesn't know where it is right now. Alan could locate it by exploring the rooms one by one in order to find it, but there is not enough time: he has to open the door. Fortunately, he recently installed the proposed tool: by pressing the switch, a short sound announces that the light is switched on. Alan can thus confidently open the door with the knowledge that the lights are on.

Scenario 2. Betty is a totally blind researcher at university. She shares the office with another colleague. Frequently Betty is the last person to leave the office. Thus, when going away, she should make sure that the lights are off. Sometimes her colleague switches off the lights when going out, even if Betty is still in the room. So Betty needs to be aware of the light state before leaving the office. To do this, she could use her smartphone, launch the specific light detector app and check if the lights are on or off. This requires a certain number of steps and gestures. Having to perform this activity every time she leaves the room is time-consuming and can become frustrating. It would make a big difference if she had the auditory tool installed in her room in order to obtain the same information by simply pressing the light switch.

Scenario 3. Chris is a totally blind person. He likes travelling very much and he is on a trip with a group of friends. He is in a single room in the hotel. Chris decides to order something to drink from reception. When the member of staff leaves the room, Chris needs to know if the lights have been switched on or off. In addition, he does not like to sleep knowing that the lights may be on, even if he cannot see the light at all. He does not have an assistive light detector with him. Fortunately, the hotel has installed the audio-based tool in the lighting system. By switching on the light Chris can recognize the very short sound signal that the light has been turned on.

Scenario 4. Diana is a totally blind woman who likes to run her own home independently. She finds modern technology unhelpful since she has difficulty interacting with touch-screen devices. She, therefore, prefers to use minimal functions on them such as calling or reading/answering text messages. Every day, before going to sleep, Diana has to check if all the lights are off. In fact, her husband and children often forget to turn off all the lights. So, performing this activity every night may require considerable effort by Diana. Sometimes she considers memorizing the on/off position of the switches but this is not always possible, especially for those lights which can be switched on from multiple positions. Fortunately, the family recently installed the auditory tool to check the light status. This allows

Diana to hear a beep when the light is switched on. As a result, this activity becomes much simpler, and Diana can save time.

3.2 Method

Our idea is to propose a stand-alone tool to be used by people who are blind, which is accessible regardless of their technical abilities and familiarity with computers and touch-screen devices. Our goal is to propose a solution able to: (1) check easily whether the light is turned on/off in a room; (2) avoid the need for the user to carry with them specific ad-hoc tools or mobile devices; (3) avoid the need for any digital skills. To this end, we designed an electronic circuit which can be installed on the home lighting system without requiring additional tools and apps. Furthermore, the proposed solution is aimed at offering a low cost tool.

3.3 Key features of our solution

We developed a stand-alone tool which can be installed on the lighting system to quickly and easily check the light status. The tool needs to be installed in each light fitting or in one switch controlling different chandeliers or lights. When the light is switched on in a room, an auditory feedback signal – i.e. a short sound - can be perceived by the user. When turned off, no sound is produced. The sound is about 2 seconds long and is reproduced via a piezoelectric buzzer of 12 V. The main features of the proposed prototype can be summarized as:

1. *Auditory feedback.* A short sound (beep) is emitted when turning the light on.
2. *Natural interaction.* Neither special portable devices (such as assistive technology), nor mobile apps, nor web applications are required. The user interacts with the tool simply by using the light switch.
3. *Easy installation.* The tool is simply inserted into the light fitting; one device is required for each fitting. A minimum amount of rewiring is required.
4. *Multiple-switching.* The user can control the status even when the set of lights can be turned on/off from different switches.
5. *Replicability.* A low cost solution, which can be developed via a relatively simple electronic circuit and adapted to different types of light fitting.
6. *Limited power consumption.* The device is a very low energy consumption tool with a minimal impact on the environment.
7. *Exploitation.* The tool can be used in combination with other smart features and provide information on the status also when an internet connection is not available.

4 First prototype

In this section we will summarize the first prototype features and the results obtained from a user study.

4.1 The auditory-based tool

In order to develop the prototype, an electronic circuit of 220V AC was designed (see Figure 1) without the use of a transformer. The circuit can be adapted also for a different voltage value (including LEDs) by replacing some electronic components. The absence of the transformer has the advantage of negligible heat generation and allows for the reduced dimensions of the device.

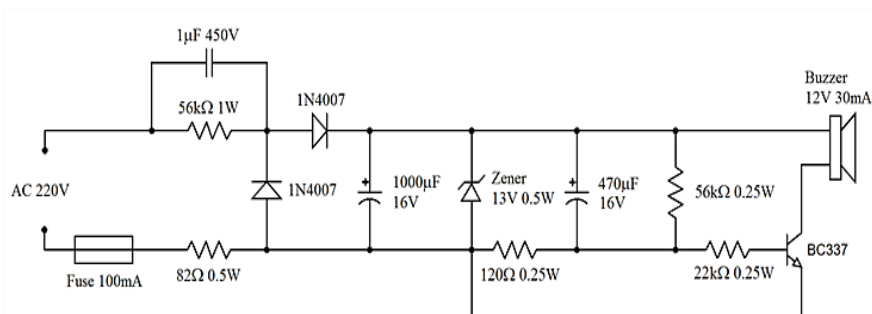

Figure 1: Diagram of the electronic circuit

The supplied voltage was reduced to 12V DC using a two-diode rectifier, two capacitors and a Zener diode. A 220 V fuse is inserted for the circuit protection.

The buzzer that emits the sound is fed via a transistor, which in turn receives the pulse from the 470 μF electrolytic capacitor and the 120 Ohm resistor ("RC" circuit). The electrolytic capacitor is quickly discharged through the 56

kOhm resistor when the 220 V AC current is switched off. The electronic circuit with all the components placed onto the circuit board is shown in Figure 2(a).

A dielectric resin epoxy was employed to embed the electronic circuit in order to protect and insulate the components in such a way that the potential hazard in touching the 220 V parts of the circuit during the installation was removed. Figure 2(b) is the image showing two prototypes encapsulated with the resin. The total cost of the components needed to build the prototype is in the order of 10 euro.

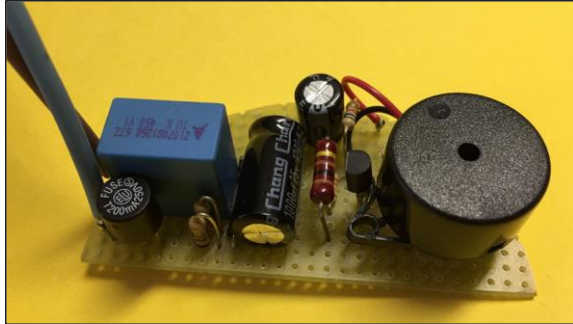

(a)



(b)

Figure 2: Image of the electronic circuit (a) and the prototypes encapsulated in the dielectric resin (b)

The connection of this electronic circuit must be carried out in parallel with the light fitting's power supply. The shape of the prototype presented here was designed to be housed inside the ceiling support of a chandelier (see Figure 3).



Figure 3: Prototype placed in the ceiling support of the chandelier

In this case a prototype device was provided in a form which is easily positioned within the fitting. Different shapes and sizes can be provided e.g. for installation inside the wall electrical box where the switch is installed or where the electrical cables which connect to the light are intercepted, or even inside the switch.

4.2 First prototype evaluation

In this section, the study conducted to evaluate the first prototype is described and discussed. Specifically, the methodology and results are reported.

4.2.1 Method

For the evaluation, seven totally blind people (aged from 26 to 77 years old; 4 male and 3 female) and five sighted users (aged from 35 to 75) were asked to use the audio-based tool. The test was conducted in order to obtain feedback from users who are totally blind as well as from sighted people. The latter were included also to understand if there is an undesired impact because the tool reproduces a sound every time the light is switched on.

The tool was installed at the home of one of the authors who has used it regularly for 4 years without any issues. Three rooms were selected to perform the test: the kitchen, bathroom and living room. The three rooms illustrated three different scenarios. In the first case, the kitchen contained just one switch and no device was installed. The second room, the bathroom, also had just one light switch, however, the device was installed. In the living room, on the contrary, there were three light switches and the device was installed.

All the participants were asked to see if and how they could determine if the light was on or off in the three rooms in the order described. The blind participants were asked to comment on the (1) usefulness of the tool, and (2) appropriateness

of the auditory feedback. Sighted users were specifically asked to indicate if the sound used to give auditory feedback would bother them. In addition, both groups were asked their preference from the four installation types: (a) light bulb, (b) light fitting, (c) switch, and (d) any of these modalities. The opinions were rated from 1 (the most negative value) to 5 (the most positive value).

4.2.2 Results from blind participants

In the kitchen, three blind people asserted it was not possible to obtain information about the light status, without using a specific device for light detection. The other blind users suggested deducing the status from the switch position. However, this would require having to memorise the position of the switches and on/off positions for all the rooms, thus requiring a considerable cognitive effort. In the living room instead, all the blind participants stated that it would be very difficult to deduce the light status from learning the position of the switch, given there were multiple switches. However, using the device which emits a beep when the light is being switched on, all the users had the opportunity to perceive the light status. Similarly, in the bathroom all the users were able to quickly check the light status just by pressing the single switch and hearing the sound (or not).

The device was particularly liked by the participants as they appreciated not having to carry any specific devices in their hand in order to carry out the task. The users provided positive comments. Five users particularly highlighted the usefulness of this device, especially when the switches do not offer an on/off position from which the light status can be figured out, and particularly when the lights can be switched on from multiple positions. One user expressed an interest in the opportunity to have such a support already integrated into common light bulbs, or into the housings where light bulbs are installed. Four people suggested using the same approach for LEDs used in appliances in order to obtain information about the status. One participant reported some difficulties in hearing the tone used for the auditory feedback clearly. However, he was 77 years old and said he does usually have some difficulty in perceiving high frequencies. Three out of seven users expressed a preference for having two different sounds to indicate the status: two beeps when the light is on, and a single sound a little longer to indicate the light is off. They had noticed this kind of auditory feedback in other appliances, such as an air-conditioner. Using this system would allow the user to be immediately sure about the light status after pressing the switch. The minimal effort involved was favourably compared to the mobile apps four participants had previously installed, which in fact they rarely use.

All the blind people reported using smartphones, but three of them stated that they would prefer not to use a mobile device for everyday activities at home. Two blind people currently have a special device – which we can consider assistive technology (AT) – in order to check the light status, four rely on an app on their smartphone (e.g. light detector), and one user relies on his memory about the position of the switches.

With regard to the usefulness of the prototype, the users gave very positive feedback: 70% expressed '5/5' and 30% '4/5' (with an average $a=4.71$ and a standard deviation $sd=0.49$). Concerning the appropriateness of the sound, the response was overall positive ($a=3.43$; $sd=0.98$) with a preference of '3/5' expressed by 43% and '4/5' by 30%. Nevertheless, the auditory feedback needs to be improved, as suggested by the users. In relation to the installation type, the majority of users would prefer to have the tool integrated within the light bulb and the other 29% directly in the switch. In particular, the two users who preferred the configuration with the tool in the switch explained this preference as the opportunity to have the sound located closer to the user.

Table 1 reports information on the users as well as their preferences expressed about tool usefulness, type of sound and installation (a stays for light bulb, b for light fitting, c for switch, and d for any modalities).

Table 1: Information about participants and feedback

User	Gender	Age	Light AT	Usefulness	Sound	Installation
1	M	26	App	4	4	a
2	F	44	App	5	4	a
3	M	45	App	5	3	c
4	F	55	Device	4	3	a
5	M	58	App	5	5	b
6	F	62	Device	5	3	a
7	M	77	-	5	2	c

4.2.3 Results from sighted participants

The five sighted people were simply asked to turn on/off the lights in the three rooms. They had no previous knowledge of the device. In the kitchen none of the users noticed anything unusual when carrying out the task. In the bathroom instead, four people were immediately surprised to hear a sound when using the switch. One user did not initially notice

the auditory feedback and had to switch the light on/off twice before associating the sound with turning on the light. At first all the sighted users found that the sound associated with the light status was slightly strange. However, after turning the light in the living room on/off a few times, they said they did not consider it significant in terms of having a negative impact on the procedure. Regarding this aspect, all the users indicated either '4/5' or '5/5' on the scale where '1' was "very bothered" and '5' "not at all bothered" by the sound ($\mu=4.4$; $sd=0.55$). Concerning the installation type, 60% of users would prefer an integration of the tool within the light bulb, 20% in the light fitting and the other 20% did not mind which. No preference was expressed for the installation in the switch. Nearly 60% of the users would prefer the tool in the light bulbs. Figure 4 shows the number of preferences expressed by all the 12 users, blind and sighted, involved in the testing.

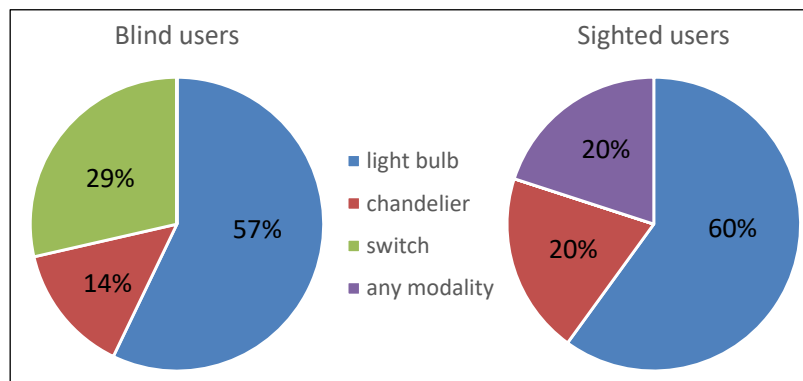

Figure 4: Installation preferences by users

4.3 First prototype summary

The first evaluation performed with 7 blind and 5 sighted people provided initial feedback about the usefulness of the proposed tool. All the blind users indicated a positive value for the usefulness of the tool. The sighted people expressed positive feedback with regard to the potential negative impact of sound associated to the light being switched off or on. The tests allowed us to collect some aspects to consider in the tool design. They can be summarised as:

1. The elderly or people with some difficulties in hearing may encounter some problems in perceiving the sound;
2. The elderly or people with some difficulties in hearing might prefer to have the sound as near as possible to their position;
3. The variety of the sound (e.g. volume, dominant frequency and length) could be different for the various rooms or lights.

The tests highlighted the usefulness of the proposed tool especially for those rooms in which the light can be turned on/off via various switches. In fact, in this case those people who usually rely on the switch position to remember the light status encountered many problems. Such a tool could resolve this type of user experience. In addition, those users who have a specific device or app to check the light state considered the proposed tool more user-friendly and better adapted to the task. Current app usage seems to be correlated to the age: younger people tended to use an app rather than a special device. The oldest person stated that they did not use any assistive technology for the light. Many users also commented that a similar approach used for the auditory-based prototype should be applied to any home appliances in which the LED lights show specific information or alerts.

The response by the sighted participants to the test was positive especially with regards to the auditory feedback. They reported that the sound produced by the tool didn't bother them. Specifically, users commented that similar sounds are nowadays produced by many household appliances, such as by refrigerators (when the door remains open for more than a certain number of minutes), the dishwasher/washing machine when it stops the washing cycle, thermostats (when setting the temperature), and so on. In this perspective, a light/switch reproducing auditory feedback is simply a tool which is added to the other home devices.

About the tool installation, most users reported a preference for the installation in the light bulb. However, this aspect should be better investigated.

5 Second prototype

In this section, a second version of the proposed prototype is firstly described, and next evaluated.

5.1 The design

Based on the feedback collected with the pilot user tests for the first prototype, a second version of the auditory-based tool was developed. Specifically, in this version the aspects observed during the evaluation have been taken into account in the tool design in order to enhance the user experience with the adapted version.

Firstly, the new prototype intended to address the issues observed about the difficulties in perceiving the auditory feedback by elderly people. Secondly, the shape and size were redesigned in order to make the tool easier to handle. Thirdly, a differentiation between the zones in the home was considered when designing the auditory feedback.

The main features added and redesigned in the second prototype can be summarised as:

- Size and shape more suited to wall electrical box-installation;
- A dominant frequency of the sound centred on 1000 Hz for a better user perception especially by elderly people;
- Various versions of the tool with two different volumes of the sound and with two different durations of the tone.

5.1.1 Shape and size

Differently from the first version, the second prototype is especially aimed at an installation in the wall, near the switch. Different shapes and sizes can be provided to guarantee various types of installation of the proposed tool. For instance, potential installation can be in the (1) wall electrical box where the switch is installed (see Figure 5), or (2) where the electrical cables that connect to the ceiling support of the light are intercepted (see Figure 3), or (3) even integrated inside the switch itself or integrated into the bulb. As a result, different shapes and smaller dimensions can be required.

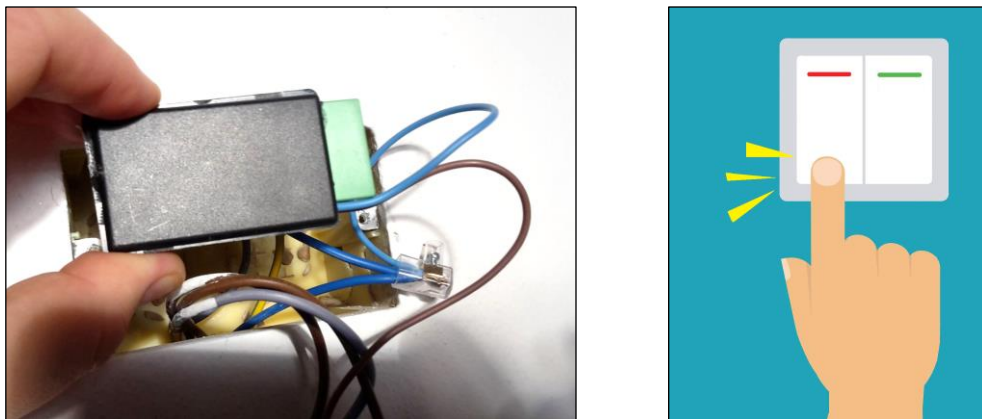

Figure 5: Prototype with a different configuration for installation inside the wall electrical box

5.1.2 Auditory differentiation

Since in the evaluation of the first prototype some difficulties were observed by elderly people in perceiving the sound at a relatively high frequency, a lower dominant frequency level of the sound was used in the second prototype.

Furthermore, we focused not only on how to improve the perception of the light status (on/off), but also on how to differentiate the types of lights. This was implemented by designing multiple versions of the prototype with different sounds in terms of volume level and length. This might be useful to differentiate the various areas in the home. Specifically, three versions with different auditory feedback to use in various contexts were designed: low feedback (low volume and about 500 ms length), medium feedback (low volume and about 1000 ms length) and high feedback (high volume and about 1000 ms length). For example, the “low feedback” version might be suitable for the bedrooms, which are quiet environments; the “medium feedback” might be applied for bathroom and corridor; the “high feedback” sound might be used for rooms like the living room, kitchen or laundry, which might be noisier. However, the auditory variation could also be applied to distinguish between the various lights available in a specific room.

5.2 Second prototype evaluation

The evaluation of the second prototype was aimed at (1) verifying the effectiveness in using the prototype to check the light state; (2) comparing the proposed tool with existing ATs for light detection; (3) assessing the perception of the various tool versions with different auditory feedback. To this end, we conducted a user test with 16 participants and a survey with 100 blind people to get more information. In this section the user test is described. The survey results are reported in the next section.

5.2.1 Participants

Sixteen totally blind people (aged from 26 to 79 years old; 11 male and 5 female) were involved in our tests. They were recruited thanks to the personal contacts by one of the authors as well as the contribution by the local site of the Italian association for the blind. All the users declared an interest in this type of tool and were aware of the mobile apps available for light detecting. All of them were asked to perform some tasks in order to evaluate the effectiveness of the proposed tool.

5.2.2 Test protocol

The tool installed at the home of one of the authors – and used in the first prototype evaluation – was replaced with the new prototype. The three auditory-based tool versions were installed in the electric boxes in the different rooms:

1. Low feedback, for three bedrooms;
2. Medium feedback, for the bathrooms and corridor;
3. High feedback, for the kitchen, living room, laundry and balcony.

The aim was to test how the different auditory feedback was perceived by the users.

The home electrical installation was equipped with a general switch available to turn off all the lights. Such a switch can be very useful to be sure to switch off all the lights when leaving home. On returning home, when the lights are switched on again, the lights that had been “on”, were automatically switched “on” again. As a result, the auditory feedback associated to those lights can be heard. In this way, the user can quickly and easily become aware that some lights are still “on”. This feature was used in our tests to evaluate if the participants were able to perceive (1) if some lights were on (see task 4 below), and (2) which rooms had lights on (see task 5).

With regards to the comparison of the prototype with the AT, the “light detector” app was selected for the purpose. This app was chosen because it is designed to perform only light detection. Other available apps (e.g., “Seeing AI” or “Seeing Assistant”) are designed for carrying out several tasks. So, in this case, the user would be required to perform many more actions to activate the light detection function. The “Light detector” app instead only needs to be launched and then it is ready to use. An iPhone X equipped with the app “light detector” was available for the user test.

Two researchers participated in the tests to (1) set up the environment (i.e. switch the lights on/off), (2) introduce the tasks to the users, (3) observe and collect information and comments by the users.

5.2.3 Tasks

All the users were asked to perform five tasks to check the lighting status and to identify which lights were on. The tasks assigned to the users are reported in Table 2. Tasks 1, 2 and 3 were assigned in order to assess the effectiveness of the tool in checking the light status in different rooms. Tasks 4 and 5 were aimed at evaluating the effectiveness of the different auditory feedback (low, medium and high) to differentiate between the rooms.

Table 2: Tasks assigned to the users for the comparative study

Task	Description
1	Check the light status in the corridor
2	Check the light status in the living room
3	Check the light status in the bedroom
4	Check if there is at least one light on
5	Indicate which light is on

For tasks 1, 2 and 3, the action required by the user was just to check the light status. These tasks were carried out both via app and prototype in order to compare them. The user had to use the app to check the status, and then verify it using our prototype via the switch. The light status was set by the researcher as “on” for the corridor and the bedroom, and “off” for the living room. Since the app may be affected by the sunlight, we also reported the windows available in the rooms. The test was in fact performed in the afternoon with outside light coming in through the windows.

For tasks 4 and 5, the general switch to turn on/off all the lights was used. Before carrying out tasks 4 and 5, the researchers involved in the experiment had to set up the environment by: (1) turning off all the lights; (2) switching off the general switch; (3) turning on the lights in the bedroom and kitchen. Thus, the user had just to put on the general switch to get information on the lights remaining on (in the bedroom and kitchen). The sounds produced by those lights could be heard as soon as the general switch was turned on.

Quantitative and qualitative data were collected for each user. Firstly, success/failure was recorded for each task. Secondly, the time required for performing tasks 1, 2 and 3 via the “Light detector” app as well as the prototype was recorded. For tasks 4 and 5 no time was recorded. In fact, these tasks would have been time-consuming using the app, as they would probably have required moving from room to room. Instead, when using the auditory-based prototype,

the user can instantly hear the beep if a light is on. For this reason, we decided not to compare the two modalities for these two tasks.

At the end of the test, each user was asked to fill in a questionnaire to express their preference between the tool and prototype.

5.3 Results

For the first three tasks, the time taken and the success/failure rate in checking the light status were recorded for the mobile detecting app only. These data were not collected for the proposed tool since the time required was just 1 or 2 seconds (i.e. the time to turn on/off the switch).

Table 4 and Table 5 report the data collected from the user test. The average time for checking the light state was 37 s (SD=8) for task1, 21 s (SD=6) for task2, and 15 s (SD=5) for task 3. For all the three tasks the actions required of the users were the same, i.e. checking the light status. For task 1 a longer time was required because the user had to perform more actions: (1) unlocking the smartphone (through a numerical code), (2) finding and launching the app, and (3) checking the status. This requires a lot of gestures on the touch-screen. When performing tasks 2 and 3, instead, the app was already open and so the user had just to use the camera of the smartphone to check the status (i.e. a lower number of actions). The average for task 1 was 37 seconds (sd=8), but we can observe that user n. 12 used only 18 seconds. This is because after performing a certain number of gestures, he decided to launch the app via voice by Apple Siri. This significantly shortened the time, as no gesture was made on the touch screen.

Table 3 shows a comparison of the steps required to detect the light status when using (1) an app (light detector), (2) a dedicated assistive technology (AT), and (3) our proposed auditory tool. All the three modes exploit a sound to inform the user about the light status. Both the app and AT reproduce a sound with different frequencies according to the light source intensity: i.e. the sound is higher when the device is pointing directly at the light source; the frequency is lower when pointing the device in another direction proportionally to the distance from the centre of light. The proposed tool gives just auditory feedback when the light is turned on.

Table 3: List of the steps needed to detect the light status via an app for smartphone, the assistive technology (AT)

Mode	Steps
App	<ol style="list-style-type: none"> 1. Locate the smartphone 2. Unlock the screen by passcode entering 3. Perform N swipe gestures to focus the app 4. Double tap to open the app 5. Point the camera towards the ceiling 6. Move the camera to detect the light source 7. Continue to move the camera to identify the light intensity through the sound frequency change
Assistive technology	<ol style="list-style-type: none"> 1. Locate the AT h 2. Point the AT towards the ceiling 3. Move the AT to detect the light source 4. Continue to move the AT to identify the light intensity through the sound frequency change
Auditory tool	<ol style="list-style-type: none"> 1. Turn on the switch

Step 3 in the App (i.e. performing N swipe gestures) includes N gestures, where N is an undefined number of gestures used to move the screen reader to focus over the desired app. The number of gestures depends on the current position as well as the strategy that the user applies to explore the touch-screen. A list of the basic commands for a screen reader on a mobile device can be found in (Apple 2020; Android Accessibility Help 2020). Regarding the auditory-based prototype, just one step (turn on the switch) is required by the user.

With regards to the success/failure of the tasks, we observed some differences between task 1, task 2 and task 3. The activities were the same, nevertheless the presence of light from the window seems to have influenced the success rate when using the app. In fact, the participants observed that the app sometimes had difficulty in precisely detecting the light source, especially when the sun was shining through the window in the room. Instead, with the auditory tool, the sound was always reproduced and only changed according to the light intensity. This is probably the reason why some uncertainties and failures occurred with some users.

By analysing the data for task accomplishment, we can observe that the majority of failures occurred for those tasks which were performed in the living room and bedroom (task 2 and 3), whereas task 1 (in the corridor) was accomplished by all the users. In the living room and bedroom there were two window-doors and one window respectively, while there was no window in the corridor.

Regarding task 4, we observed that all the users were able to identify that at least one light was on. In fact, when pressing the general switch to turn on/off all the lights, at least one sound was perceived by each user. With regards to the rooms in which the lights were on (task 5), four users (75%) were not able to accomplish the task. We can observe that the four users were older than the others (i.e. average age 72 years) and thus maybe they could have had some difficulty in distinguishing between the differences between the three types of auditory feedback. As mentioned, no time was recorded for these two tasks, because the mobile app was not used for them. In fact, it would have been very time-consuming. On the contrary, by using the proposed tool the user had just to press the general switch to turn on the lights in order to hear some auditory feedback related to the lights which were on.

Table 4: Time and accomplishment per task for each user

User	Age	T1 time in seconds (corridor)	T1 success	T2 time in seconds (living room)	T2 success	T3 time in seconds (bedroom)	T3 success	T4 success	T5 success
1	28	28	yes	16	yes	12	yes	yes	yes
2	29	30	yes	18	yes	11	yes	yes	yes
3	39	34	yes	14	no	10	yes	yes	yes
4	43	33	yes	18	yes	12	yes	yes	yes
5	58	38	yes	16	yes	14	no	yes	no
6	63	44	yes	20	no	17	yes	yes	yes
7	73	42	yes	22	no	16	yes	yes	yes
8	76	50	yes	32	no	27	no	yes	no
9	58	36	yes	24	Yes	11	yes	yes	yes
10	62	40	yes	28	No	16	no	yes	yes
11	79	52	yes	33	No	25	yes	yes	no
12	45	18	yes	14	Yes	8	yes	yes	yes
13	69	34	yes	21	Yes	18	yes	yes	yes
14	26	32	yes	17	No	14	yes	yes	yes
15	52	43	yes	25	No	19	no	yes	yes
16	28	33	yes	19	Yes	10	yes	yes	yes

Table 5: Summary of average time to carry out the tasks and task success/failure

Task	Average time, s	St.Dev, s	Success	Success, %	Failure	Failure, %
1	37	8	16	100%	0	0%
2	21	6	8	50%	8	50%
3	15	5	12	75%	4	25%
4			16	100%	0	0%
5			13	81%	3	19%

The users gave positive comments and showed interest in using such a device in the home. They explained that, when possible, they use the switch positions to check the light status. Unfortunately, this approach works only for very few rooms (like kitchen or bathroom). Consequently, they reported that the proposed tool could make it much easier to carry out this everyday task. More specifically, with regards to the usefulness of such a tool, all the users indicated either '4/5' or '5/5' on the scale where '1' was "not at all useful" and '5' "very useful" (a=4,63; sd=0,50). With reference to the sound appropriateness, the users expressed values of '3/5', '4/5' and '5/5' (a=4,0; sd=0,63). The participants declared the opportunity to use the prototype in combination with smart objects in order to provide both a (a) basic level and (b) more advanced support in accessibility in smart homes for everybody. They encouraged the researchers to continue this work to further explore the idea of using the tool in many other situations.

6 Survey

In this section we describe a survey we conducted to collect more information on (1) interest in a potential tool to support a blind person in getting information about the light status and (2) possible issues encountered when using existing ATs to check the light status, as appropriate. For our purpose, an online questionnaire was used to collect qualitative and subjective data.

6.1 Questionnaire

A questionnaire with 16 questions was formulated. The 16 questions were organized into 3 sections aimed at gathering data on: section A, general information on the participants; section B, if appropriate, the ATs (hardware or software) used to check the status of the light and possible difficulties encountered while performing the task; section C, interest and suggestions for a device like the proposed prototype. The questionnaire was created via Google Form and made available online.

More specifically, the questions were aimed at gathering information on:

- Section A: gender, special needs, age and use of smartphone;
- Section B: use of specific ATs for checking the light status, apps on smartphones to detect the light status, home automation systems, possible difficulties encountered while using those devices;
- Section C: interest in a tool that can instantly provide the light on status, the type of feedback given to indicate the “ON” status, the expected cost for such a device, and the preferred integration type (light fitting, light bulbs, or switches).
- Comments and suggestions: through an open field, the user could specify suggestions and other aspects to consider for researchers and companies in this field.

6.2 Participants

The questionnaire was circulated online among visually-impaired community groups, via e-mail, Facebook, websites of news and information on the disability world. In addition, it was included in messages sent to direct contacts of one of the authors, as well as members of the Association for the Blind in Italy. The questionnaire was open to anyone, in order to collect any additional comments by potential people interested in this topic. In fact, some technicians as well as architects with expertise in accessibility and home design answered the questions. Also, some parents, as well as teachers, expressed some opinions. In particular, with regards to the vision impairments, interest was expressed by totally blind people and those visually-impaired people who have difficulty in perceiving light.

144 people answered the questionnaire: 100 visually-impaired (88 blind and 12 partially sighted), and 39 sighted people interested in expressing an opinion (parents, architects and experts in accessibility). For our purposes, only data related to the visually-impaired and other disabilities have been analysed. About the data related to the sighted participants, the aim was to collect possible comments and impressions to understand if there could be a possible negative impact of the proposed tool.

The age of the participants (55.3% male, 44.7% female, as reported in Figure 6) ranged from 25 to 88 years. 73.5% used an IOS smartphone, 17.6% an Android smartphone, and the rest of the users, no smartphone. Five (elderly) blind users reported using a phone specifically designed for the blind, and dated Symbian-based Nokia devices.

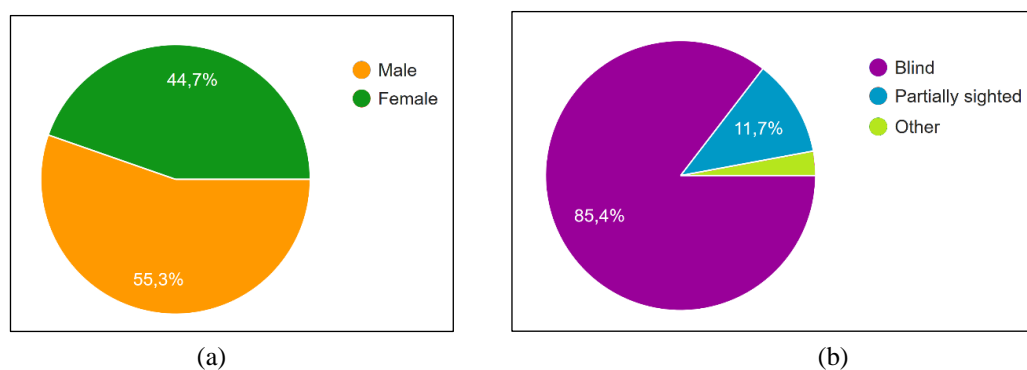

Figure 6: Gender (a) and special needs (b)

6.3 Results

The questions in section B were aimed at collecting information on the usage of assistive technologies (special portable devices or mobile apps) specifically designed to check the light status by a blind person. Firstly, the participants were asked about “the need to autonomously check the light status”: 88.7% expressed this need.

With regards to the “usage of existing AT tools specifically designed to check the light status”, 34 people (33.3%) reported using or having tried to use a special portable AT, 45 (44.1%) a specific mobile app, and 11 (10.8%) people a home automation system (see Figure 7). About 67% rarely or sometimes use specific devices or mobile apps (see Figure 8). The following charts show the gathered data on the usage of assistive technology tools used to get information on the light status.

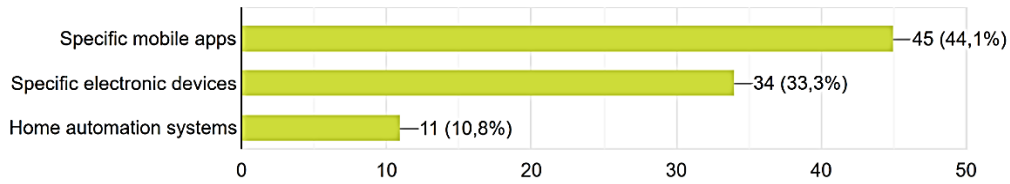

Figure 7: Assistive Technology tools used for checking the light status

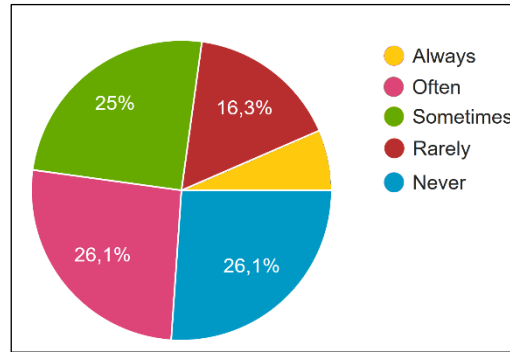

Figure 8: Frequency of use of specific AT tools

Through an explicit question, users were asked to specify any difficulties encountered in using the AT tools. Many users reported finding some issues while using the AT portable devices and mobile apps to control the light status. The main issues can be summarised as: “Need to keep the device or smartphone at hand”, “Unreliability in detecting the light status when there are various light sources”, and “Large number of actions to perform on touch-screen to launch the app”. Many users reported more than one issue related to the use of AT tools. Table 6 summarizes the gathered data.

Table 6: Difficulties encountered in using the AT tools (special devices, mobile apps and home automation systems)

Difficulties	N. users	%
Need to always have the device or smartphone at hand	57	60.6%
Unreliability in detecting the light status when there are various light sources	43	45.7%
Large number of actions to perform on touch-screen to launch the app	36	38.3%

Section C was aimed at collecting information, preferences and suggestions for a potential new AT device. 94% of the participants expressed an interest in a “proposed device integrated in the lighting system, which provides immediate feedback when turning on the light” and does not require a portable device (see Figure 9).

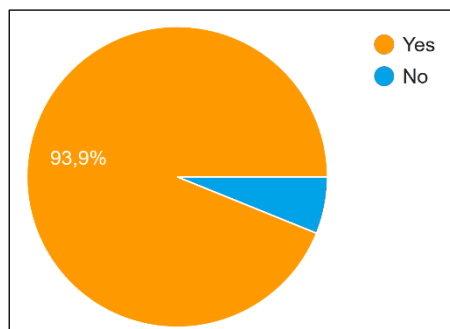

Figure 9: Participants interested in having a potential AT device integrated with the lighting system

Some questions were aimed at collecting users’ preferences regarding (1) the installation type, (2) the auditory feedback, and (3) what they would like to be able to check autonomously. An expected cost for such a device to be installed for each light or light source was also investigated.

Concerning the first aspect, i.e. “installation type”, the majority of users stated they preferred to have the device “installed in the switch” (86%). However, those who preferred the device “Integrated in the bulbs” (8%) explained the

preference for having a combination of a basic solution (the proposed device) with a smart solution. We suppose they were thinking of smart bulbs. The pie chart in Figure 10 shows the installation preferences.

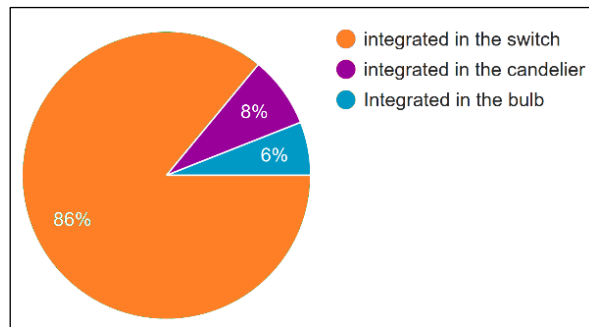

Figure 10: Preferences expressed by 100 users about the installation type

Concerning the “type of auditory feedback when the light is turned on/off”, 51% of users expressed the preference for “Two different types of sounds (to differentiate between on and off)” and 37% for “One sound only when the light is turned on”. The remaining participants expressed different preferences. Table 7 reports all the preferences expressed by the visually-impaired participants. The two preferences expressed as an alternative to those most often chosen are “pre-recorded audio messages” (3 preferences) and “vibration-based feedback” (3 preferences). One user indicated “Just a beep”, which is very similar to the preference “One sound”; however, we can interpret this expression as a choice for a “very short sound”.

Table 7: Preferences expressed by the 100 users about the type of feedback when the light is turned on/off

Type of feedback	N. preferences
Two different types of sounds (to differentiate between light on and off)	51
One sound only when the light is turned on	37
pre-recorded audio messages	3
Vibration	3
Indifferently	3
Just a beep	1
Different sounds according to different home zone	1
sound variable proportionally to the light intensity	1

Users were asked to suggest potential use for the device. Most of the proposals were related to “hotels” (66 people) and “offices” (50 people). Other proposals were also made by the interviewees (see Table 8). Indeed some proposals are very similar and therefore could be merged. However, their details can better clarify the users’ expectations and suggestions.

Table 8: Proposals of the possible use of the device

Usage	N. users
Hotel	66
Office	50
Condominium	5
Home appliances	4
Public environments	6
Devices equipped with leds	4
Power bank	2
University	1
School	1
Any switch	1

To the question related to the cost expected for a possible new AT device, only 67 users provided an indication. Most of them expect a cost around 10 euros, although some people have also expressed values like 20 euros. Three people who

did not express an expected value, specified that they would like to have the device included in a common switch, with an additional small cost for it.

Finally, users were also asked to express which information they would like to know (see Figure 11). Most preferences were related the opportunity to “check what lights are on at home”. Indeed, such a feature requires a smart approach which needs an internet connection to be able to do it remotely. The second preference was related to the possibility to “check immediately the light status when it goes on”. This feature can be provided via a device like the one we are proposing. However, it could be also designed in a smart solution.

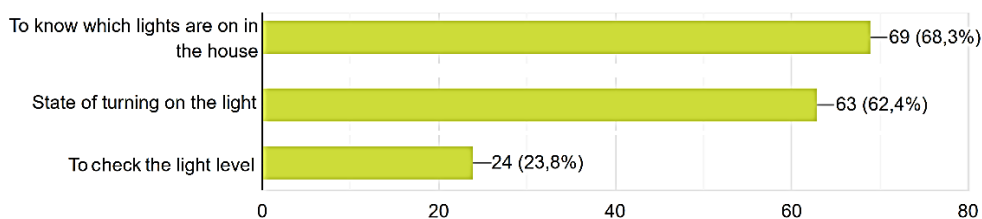

NB decimal places should be used with a full stop eg 68.3%

Figure 11: Preferences of possible features to check autonomously

6.4 Additional comments

In short, the comments left by the visually-impaired participating in our survey backed up or gave more details of their answers to specific questions. Some users confirmed that it would be useful to also have vibration feedback integrated in the switches. Furthermore, a similar device would also be useful for a led-based device which could make a sound when it was turned on. Positive comments were related to the fact that the device does not need an internet connection, so can guarantee its functionalities even if the network is unavailable or not working. However, other comments suggest integrating the proposed audio-based switch with smart solutions, by simply making it wi-fi based. One person commented that she is pleased with her portable AT device, but that an audio-based switch would make checking the lights much faster and easier. Some expectations were related to checking the partial switching on of the lights in some chandeliers, the intensity of various lights and of the different areas in the house. One idea was that the proposed device could be bought with a common switch, but it should also be available separately without having to change all the switches in the home.

Other comments were reported by the three sighted people. Two architects expressed interest in the proposed device since it could be useful to use it in the design of new environments accessible from the beginning. The other user was the parent of a blind child, and she expressed a positive opinion about the use of the device even by children so that they can become familiar with the concept of lights being on or off.

7 Discussion and suggestions

The tool we propose is a potential aid for visually-impaired people in acquiring the lighting status via simple tasks: by just switching on/off the lights. The evaluation through the various user tests revealed that the tool is suitable for quickly checking the light status (1 or 2 seconds). It compares very favourably in terms of time and effort involved if compared with a mobile app specifically designed for detecting the light status. The three versions (low, medium and high feedback) designed for distinguishing between different lights or zones are a potential way to provide additional support to the user. 19% of the users (3 out of 16) had some difficulties in identifying the different zones, but all the users were able to identify very quickly that at least one light was still on by just turning on the general switch. This result might depend on the context and the environment, but the three versions can be considered suitable also for this kind of need.

The survey conducted with the 100 visually-impaired people confirmed the interest in the proposed device by the community. Also, the difficulties reported by the interviewees confirmed those we observed in task 1 and 2, while using the specific mobile apps to check the light status. The survey confirmed also that integrating the device with common switches is preferred by blind people.

The proposed solution is technically simple considering that it is just an electronic circuit, but at the same time it can represent a valuable idea to provide an accessible and useful service at home for people with disabilities. A Home Automation System is nowadays clearly a very useful approach for a person with a disability. However, not all disabled people feel confident or able to perform all activities via smartphones or desktop applications. For instance, one user interviewed reported that she was not able to check the status of the lights with her home automation system. Another user reported that she was not able to check the status via the personal assistant Alexa. Furthermore, repetitive tasks may require a lot of effort via gestures and commands. From this perspective, a basic tool such as that proposed can

provide important support for people who cannot see and wish to carry out repeated tasks such as everyday activities in a more practical and easy way (as expressed also by some people interviewed). This means that basic functionalities could be made accessible in some way. The work (Buzzi et al., 2019) proposes a set of possible design guidelines for a web-based application to obtain accessible and usable web-based interfaces for screen reading interaction. Such a web-based application – as occurs for mobile apps – certainly offers many opportunities for those users who usually rely on smartphones for many activities. However, some everyday tasks and activities need to be rapidly handled while performing them and possibly without requiring an internet connection. For example, a coffee machine might have a certain number of LEDs to give information about the water or coffee supply. To check them in a practical way, a non-app/web solution should be considered for a quick and easy interaction. So, some type of auditory feedback could be basic support for blind people to understand what the machine needs. Moreover, such a tool could be used not only at home but also in other situations, such as in public buildings, as confirmed also by the survey. Therefore, the idea we propose could be applied - with the necessary changes – to the problems described for the coffee machine or in other environments. In this context, low cost solutions and simple and easy assistive technologies should be proposed by research institutions and industry.

Some potential use cases and advantages can be summarized as:

1. Installation in hotels, office and hospitals, or buildings with no wireless connection able to support a Home Automation device;
2. Integration with smart light bulbs, or any other smart home appliance in order to obtain a unique smart object to be used in a simple way or with a Home Automation System;
3. Guarantee of continued support thanks to the robustness even when Wi-Fi is absent or does not work and therefore the Home Automation is down.

To this end, research should be encouraged to investigate both tools and solutions for supporting blind people not only with advanced skills in digital technology but also for those who are not particularly familiar or competent with mobile devices and touch-screens. Moreover, short and repetitive activities should be easily performed also with minimal effort. The tool herein presented intends to be an example to illustrate how to develop also simple solutions, which exploit technology without requiring great skill by users. However, a combination of a basic solution with a smart one can provide real benefit for everyone.

8 Design Recommendations

From the results of the user tests and especially from the survey, some important points to be considered have been drawn up. and used to provide some indications. Recommendations for designers of ATs to bear in mind can be summarised as:

1. Try to include accessibility features in common devices (e.g. feedback to indicate the lighting status via a standard switch);
2. Make a clear distinction between different events/notifications (e.g. light on vs light off); This could be indicated using different types of feedback, sounds or combinations of them;
3. Use a variety of forms, both auditory and tactile, to provide feedback to the user;
4. Combine basic accessibility features with more advanced smart functionalities in order to provide a suitable interaction regardless of the skills, technology and context of the user ;
5. Avoid relying on an internet connection for basic and important accessibility features, thus providing reliable and robust services and features;
6. Avoid relying on smart devices for basic and important accessibility features and services, thus making them truly accessible to everyone regardless of skills, age and familiarity with technology. This also makes interaction and use easier and more practical for everyday activities;
7. Maximise the use of low-cost solutions in order to make it more affordable and usable in real contexts by everyone.

9 Conclusions

Everyday activities and tasks, especially those which are repetitive, should be able to be carried out with a minimal amount of effort and need for particular skills or technology. In this work, we consider the specific task of checking the lighting status from the point of view of people who are totally blind. This case study can make a contribution to assistive technology design. To this end, we have presented a potential stand-alone auditory tool to indicate to blind users whether they are switching on or off a light in a room. Our prototype has been conceived as a low cost solution easily replicable for any light in the home, offices, hotels, public spaces or in buildings with no wireless connection able to support a Home Automation device. The concept of giving auditory feedback on status can be extended to appliances which have a series of LEDs: e.g., a coffee machine, through the use of sounds at different pitches.

The contribution of this study is, firstly, to introduce a tool based simply on an electronic circuit, exemplifying a basic level of accessibility which can be applied to many products, such as light bulbs or LED. It thus highlights the potential for commercial exploitation, via inbuilt or add-on devices. Two kinds of prototype were designed to give further support to blind people in detecting more efficiently and quickly the lighting status. In particular, for the redesigned prototype, three different tool versions with a low, medium and high level of feedback have been presented as a case study for potential everyday applications. Evaluation by various groups of users confirmed the usefulness of the tool for the specific task and at the same time revealed the limitations and issues related to existing special AT tools. Secondly, this work reports the results of a survey conducted with 100 visually-impaired users. The survey confirmed the feedback collected from the user tests and provided some additional information, especially through suggestions and specific feedback. In particular, the users' preferences regarding feedback and the type of installation could be useful for designers of assistive technology and supporting tools for blind people. The survey also highlighted the limitations of existing assistive technology tools specifically designed for checking the lighting status via audio or vibration feedback. It was reported that they are not practical for everyday repeated use and require a certain familiarity and technical skill in using mobile devices. As a result, 94% of the users stated they were interested in a possible device to be integrated into a lighting system. This could make the repetitive task of checking the lighting status simpler and easier to carry out, and at the same time offer a basic accessible solution for the general public. Some of the comments and suggestions which emerged from the survey highlighted that a combination of a basic accessible solution with a smart approach using personal assistants or any other tools should be further investigated and tested. Seven potential points to consider for ATs designers have thus been proposed. A multimodal interaction can represent a valuable solution more suitable and satisfying for the end-users. Further studies should investigate in this direction.

REFERENCES

- Alemdar, H., & Ersoy, C. (2017). Multi-resident activity tracking and recognition in smart environments. *Journal of Ambient Intelligence and Humanized Computing*, 8(4), 513-529.
- Amiribesheli, M., Benmansour, A., & Bouchachia, A. (2015). A review of smart homes in healthcare. *Journal of Ambient Intelligence and Humanized Computing*, 6(4), 495-517.
- Azimi, I., Rahmani, A. M., Liljeberg, P., & Tenhunen, H. (2017). Internet of things for remote elderly monitoring: a study from user-centered perspective. *Journal of Ambient Intelligence and Humanized Computing*, 8(2), 273-289.
- Apple (2020). VoiceOver standard gestures, <https://help.apple.com/voiceover/info/guide/10.11/en.lproj/vo27992.html> [Accessed 16 March 2020].
- Android Accessibility Help (2020). Use TalkBack gestures, <https://support.google.com/accessibility/android/answer/6151827?hl=en> [Accessed 16 March 2020].
- Buchmayr, M., & Kurschl, W. (2011). A survey on situation-aware ambient intelligence systems. *Journal of Ambient Intelligence and Humanized Computing*, 2(3), 175-183.
- Buzzi, M. C., Buzzi, M., Leporini, B., & Trujillo, A. (2015, August). Design of web-based tools to study blind people's touch-based interaction with smartphones. In *International Conference on Human-Computer Interaction* (pp. 7-12). Springer, Cham.
- Buzzi, M., Leporini, B., & Meattini, C. (2019). Design Guidelines for Web Interfaces of Home Automation Systems Accessible via Screen Reader. *Journal of Web Engineering*, 18(4), 477-512.
- Carvalho, M. C. N., Dias, F. S., Reis, A. G. S., & Freire, A. P. (2018, April). Accessibility and usability problems encountered on websites and applications in mobile devices by blind and normal-vision users. In *Proceedings of the 33rd Annual ACM Symposium on Applied Computing* (pp. 2022-2029).
- Chen, S. C., Wu, C. M., Chen, Y. J., Chin, J. T., & Chen, Y. Y. (2017, May). Smart home control for the people with severe disabilities. In *Applied System Innovation (ICASI), 2017 International Conference on* (pp. 503-506). IEEE.
- Cook, A. M., & Polgar, J. M. (2014). *Assistive Technologies-E-Book: Principles and Practice*. Elsevier Health Sciences.
- Costa, L. C., Almeida, N. S., Correa, A. G., Lopes, R. D., & Zuffo, M. K. (2013). Accessible display design to control home area networks. *IEEE Transactions on Consumer Electronics*, 59(2), 422-427.
- Damaceno, R. J. P., Braga, J. C., & Mena-Chalco, J. P. (2018). Mobile device accessibility for the visually impaired: problems mapping and recommendations. *Universal Access in the Information Society*, 17(2), 421-435.

- Debes, C., Merentitis, A., Sukhanov, S., Niessen, M., Frangiadakis, N., & Bauer, A. (2016). Monitoring activities of daily living in smart homes: Understanding human behavior. *IEEE Signal Processing Magazine*, 33(2), 81-94.
- El-Basioni, B. M. M., El-Kader, S. M. A., & Eissa, H. S. (2014). Independent living for persons with disabilities and elderly people using smart home technology. *International Journal of Application or Innovation in Engineering and Management*, 3(4), 11-28.
- EveryWare Technologies (2020). Light detector, <http://www.everywaretechnologies.com/apps/lightdetector> [Accessed 16 September 2019].
- Freeman, E., Wilson, G., & Brewster, S. (2016, October). Automatically Adapting Home Lighting to Assist Visually Impaired Children. In *Proceedings of the 9th Nordic Conference on Human-Computer Interaction* (p. 107). ACM.
- Hersh, M., & Johnson, M. A. (Eds.). (2010). *Assistive technology for visually impaired and blind people*. Springer Science & Business Media.
- Jeet, V., Dhillon, H. S., & Bhatia, S. (2015, April). Radio frequency home appliance control based on head tracking and voice control for disabled person. In *Communication Systems and Network Technologies (CSNT), 2015 Fifth International Conference on* (pp. 559-563). IEEE.
- Jones, N., Bartlett, H. E., & Cooke, R. (2019). An analysis of the impact of visual impairment on activities of daily living and vision-related quality of life in a visually impaired adult population. *British Journal of Visual Impairment*, 37(1), 50-63.
- Leporini, B. and Buzzi, M. (2018). Home Automation for an Independent Living: Investigating the Needs of Visually Impaired People. In: *Proc. of the 15th International Cross-Disciplinary Conference on Web Accessibility, W4A2018* (Lyon, France, April 23-25, 2018), ACM.
- Leporini, B., Rosellini, M., & Forgione, N. (2019, June). Is the light on or off?: a simple auditory-based tool to help visually-impaired people check the light device status. In *Proceedings of the 12th ACM International Conference on Pervasive Technologies Related to Assistive Environments* (pp. 152-155). ACM.
- Living made easy (2020). Light probes or detectors, <https://www.livingmadeeasy.org.uk/communication/light-probes-or-detectors-1381-p/> [Accessed 16 March 2020].
- Lotfi, A., Langensiepen, C., Mahmoud, S. M., & Akhlaghinia, M. J. (2012). Smart homes for the elderly dementia sufferers: identification and prediction of abnormal behaviour. *Journal of ambient intelligence and humanized computing*, 3(3), 205-218.
- Mennicken, S., Hwang, A., Yang, R., Hoey, J., Mihailidis, A., & Huang, E. M. (2015, April). Smart for life: Designing smart home technologies that evolve with users. In *Proc. of the 33rd Annual ACM Conference Extended Abstracts on Human Factors in Computing Systems* (pp. 2377-2380). ACM.
- Mekuria, D. N., Sernani, P., Falcionelli, N., & Dragoni, A. F. (2019). Smart home reasoning systems: a systematic literature review. *Journal of Ambient Intelligence and Humanized Computing*, 1-18.
- Microsoft (2020). Seeing AI, <https://www.microsoft.com/en-us/seeing-ai> [Accessed 16 March 2020].
- Mtshali, P., & Khubisa, F. (2019). A Smart Home Appliance Control System for Physically Disabled People. In *2019 Conference on Information Communications Technology and Society (ICTAS)* (pp. 1-5). IEEE.
- Plantevin, V., Bouzouane, A., Bouchard, B., & Gaboury, S. (2019). Towards a more reliable and scalable architecture for smart home environments. *Journal of Ambient Intelligence and Humanized Computing*, 10(7), 2645-2656.
- Poncela, A., Coslado, F., García, B., Fernández, M., Ariza, J., Peinado, G., ... & Sandoval, F. (2019). Smart care home system: a platform for eAssistance. *Journal of Ambient Intelligence and Humanized Computing*, 10(10), 3997-4021.
- Power, C., Freire, A., Petrie, H., & Swallow, D. (2012, May). Guidelines are only half of the story: accessibility problems encountered by blind users on the web. In *Proceedings of the SIGCHI conference on human factors in computing systems* (pp. 433-442). ACM.
- RNIB (2020). Colorino talking colour identifier & light detector, <https://shop.rnib.org.uk/colorino-talking-colour-detector.html> [Accessed 16 March 2020].
- Rodrigues, A., Montague, K., Nicolau, H., & Guerreiro, T. (2015, October). Getting smartphones to TalkBack: understanding the smartphone adoption process of blind users. In *Proceedings of the 17th International ACM SIGACCESS Conference on Computers & Accessibility* (pp. 23-32). ACM.
- Sierra, J. S., & Togores, J. (2012). Designing mobile apps for visually impaired and blind users. In *The Fifth International Conference on Advances in Computer-Human Interactions, 2012* (pp. 47-52).

- Tahir, S. F., Fahad, L. G., & Kifayat, K. (2019). Key feature identification for recognition of activities performed by a smart-home resident. *Journal of Ambient Intelligence and Humanized Computing*, 1-11.
- Transition Technologies S.A. (2020). Seeing Assistant Light source detector <http://seeingassistant.tt.com.pl/light/> [Accessed 16 March 2020].
- Wahl, H. W., Oswald, F., & Zimprich, D. (1999). Everyday competence in visually impaired older adults: A case for person-environment perspectives. *The Gerontologist*, 39(2), 140-149.
- Wang, S., & Yu, J. (2017). Everyday information behaviour of the visually impaired in China. *Information Research: An International Electronic Journal*, 22(1), n1.
- Xin, T., Guo, B., Wang, Z., Wang, P., & Yu, Z. (2018). FreeSense: human-behavior understanding using Wi-Fi signals. *Journal of Ambient Intelligence and Humanized Computing*, 9(5), 1611-1622.
- Yuan, C. W., Hanrahan, B. V., Lee, S., Rosson, M. B., & Carroll, J. M. (2017). Constructing a holistic view of shopping with people with visual impairment: a participatory design approach. *Universal Access in the Information Society*, 18(1), 127-140.