

# U-PHOS Project: Development of a Large Diameter Pulsating Heat Pipe Experiment on board REXUS 22

P Nannipieri<sup>1</sup>, M Anichini<sup>1</sup>, L Barsocchi<sup>1</sup>, G Becatti<sup>1</sup>, L Buoni<sup>1</sup>, F Celi<sup>1</sup>, A Catarsi<sup>1</sup>, P Di Giorgio<sup>1</sup>, P Fattibene<sup>1</sup>, E Ferrato<sup>1</sup>, P Guardati<sup>1</sup>, E Mancini<sup>1</sup>, G Meoni<sup>1</sup>, F Nesti<sup>1</sup>, S Piacquadio<sup>1</sup>, E Pratelli<sup>1</sup>, L Quadrelli<sup>1</sup>, A S Viglione<sup>1</sup>, F Zanaboni<sup>1</sup>, M Mameli<sup>1\*</sup>, F Baronti<sup>1</sup>, L Fanucci<sup>1</sup>, S Marcuccio<sup>1</sup>, C Bartoli<sup>1</sup>, P Di Marco<sup>1</sup>, N Bianco<sup>2</sup>, M Marengo<sup>3</sup>, S Filippeschi<sup>1</sup>.

<sup>1</sup> University of Pisa, Largo Lucio Lazzarino 2, 56122 Pisa, Italy.

<sup>2</sup> University of Naples Federico II, Corso Umberto I, 40, 80138, Naples, Italy.

<sup>3</sup> University of Brighton, Lewes Rd, Brighton BN2 4AT, United Kingdom.

\*Corresponding Author Email: mauro.mameli@ing.unipi.it

**Abstract.** U-PHOS Project aims at analysing and characterising the behaviour of a large diameter Pulsating Heat Pipe (PHP) on board REXUS 22 sounding rocket. A PHP is a passive thermal control device where the heat is efficiently transported by means of the self-sustained oscillatory fluid motion driven by the phase change phenomena. Since, in milli-gravity conditions, buoyancy forces become less intense, the PHP diameter may be increased still maintaining the slug/plug typical flow pattern. Consequently, the PHP heat power capability may be increased too. U-PHOS aims at proving that a large diameter PHP effectively works in milli-g conditions by characterizing its thermal response during a sounding rocket flight. The actual PHP tube is made of aluminum (3 mm inner diameter, filled with FC-72), heated at the evaporator by a compact electrical resistance, cooled at the condenser by a Phase Change Material (PCM) embedded in a metallic foam. The tube wall temperatures are recorded by means of Fibre Bragg Grating (FBG) sensors; the local fluid pressure is acquired by means of a pressure transducer. The present work intends to report the actual status of the project, focusing in particular on the experiment improvements with respect to the previous campaign.

**Keywords:** Large Diameter Pulsating Heat Pipe, Sounding Rocket, Milli-gravity.

## 1 Introduction

Passive systems such as heat pipes are becoming the most popular choice for high heat power dissipation in electronics. The Pulsating Heat Pipe (PHP), patented by Akachi [1], [2], is a relatively new member of the Heat Pipe family and consists of a serpentine capillary tube, folded in many turns and closed end-to-end in a loop. The tube is first evacuated and then partially filled with a refrigerant fluid which naturally resides in the forms of liquid slugs and vapor plugs. The oscillatory motion of the slugs and plugs due to phase change phenomena allows transportation of heat. In order to obtain the desired liquid slugs/vapor plugs flow regime in ground conditions, the internal tube diameter must be smaller than a critical value (static Bond criterion).

$$d_{cr} = 2 \sqrt{\frac{\sigma}{g(\rho_l - \rho_v)}}$$



The fluid motion is indeed activated when the system is heated up in the evaporator section: the vapor bubbles expand and push the liquid slugs towards the condenser zone, where the heat is released to the cold source and the condensation process occurs. From the theoretical point of view, just by considering the static Bond criterion, it seems that in reduced gravity conditions, the inner tube diameter may be increased. Actually, Gu et al [3] and Mameli et al [4] asserted that viscous and inertial effects always play a significant role in the definition of the flow pattern within the device that cannot be discounted. Not surprisingly, considering the new dynamic confinement criterion based on Weber and Garimella numbers, it seems that a two-phase loop may still work as a PHP in reduced gravity conditions with an inner tube diameter larger than the one evaluated on static ground conditions. In order to assess the validity of the previous assertion, it is necessary to conduct experiments in a reduced gravity environment, to decouple completely the inertial effects from buoyancy. Based on the above consideration, Mangini et al. [5] tested a PHP with an inner diameter of 3mm larger than the critical diameter calculated on static Earth gravity condition (1.7mm for FC-72 at 20°C) both on ground and on milli-gravity condition, experienced during ESA 61st Parabolic flight campaign. On ground, the device works as a closed loop two-phase thermosiphon when gravity assisted, and as a pure conductive medium when placed horizontally. When gravity level decreases, a sudden transition of the flow pattern from stratified to slug flow appears, and the device is able to work as a PHP.

The reduced gravity environment experienced during the parabolic flight is not long enough (20s) to reach an operational steady state. In order to obtain a longer period of milli-g, PHOS experiment tested a large diameter PHP on board REXUS 18 sounding rocket [6,7,8]. PHOS did not experience the reduced gravity environment due to a failure of the rocket de-spin system, thus, despite the test rig was perfectly operating, no significant results have been obtained for the characterization of a PHP, except on ground condition. U-PHOS is born from the necessity to perform a second test of the PHP in a long enough milli-g environment, because of the failure of the previous one. The aim of this work is to illustrate the objectives and the test-cell improvements with respect to the PHOS project and the expected results coming from the next REXUS 22 sounding rocket campaign. The experiment is going to be launched in March 2017, on board of REXUS 22 rocket, with an expected milli-gravity environment lasting almost 90s. The inner diameter is the same of PHOS experiment (3mm), with a new, more compact design very similar to the experiment that will be tested on the International Space Station. The secondary goal of the project is to use a different cooling system consisting of a phase change material (PCM), i.e. paraffin wax, embedded with a metal foam.

## 2 Experimental set-up

The test-cell of the experiment consists of a closed-loop PHP, a heat source which provides the thermal power to the evaporator section, and a composite metal foam/PCM heat sink.

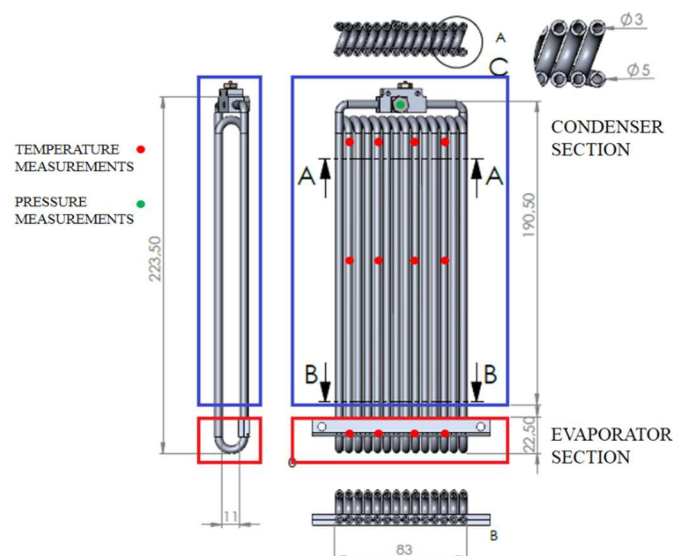

Figure 1: Test-Cell Overview (all values are millimetres).

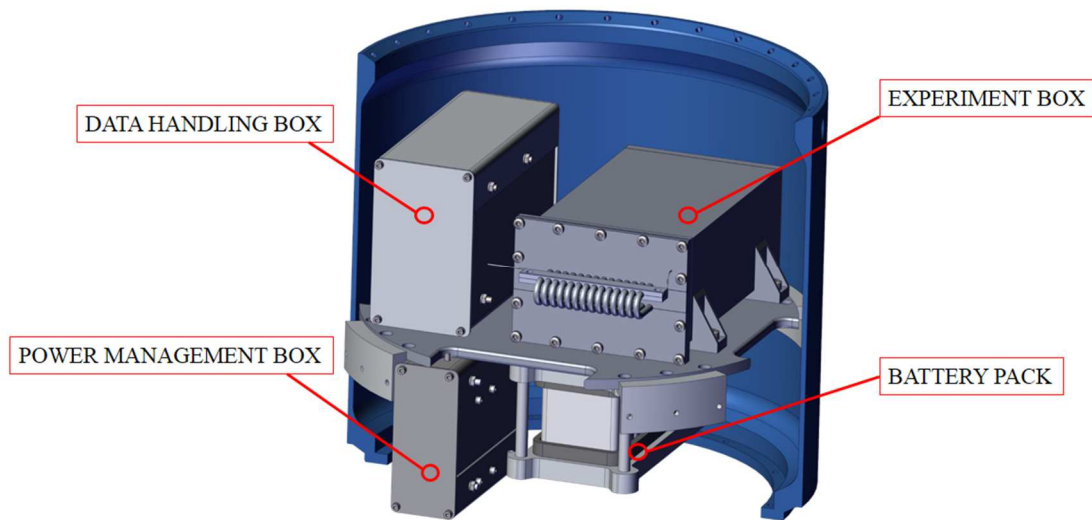

Figure 2 Experiment Assembly.

The condenser section of the PHP and the PCM are contained inside an airtight box (named experiment box), in order to avoid any hazardous leakage of PCM. The evaporator section of the PHP emerges from the experiment box and hosts the thermo-heater elements.

The test-cell and the peripheral facilities are mounted inside a cylindrical module, which constitutes the REXUS 22 rocket casing. The peripheral facilities include the battery pack, in order to provide power to the electrical heater and the experiment; the data handling unit, which contains the electronic boards for the management of the data on board; and the power management unit, including the electronics boards able to control the power to the experiment. The test-cell drawings and the architecture of the entire experiment are shown in figure 1 and figure 2.

### 2.1 Test-cell

The PHP is made of annealed aluminum (6063) tube with inner diameter of 3 mm and outer diameter of 5 mm. The tube is folded in a single loop with fourteen turns at the evaporator, arranged in a staggered configuration, as illustrated in Figure 3. The tube is closed in a loop by a T-junction, with two additional ports: one used for the emptying and filling procedures, the other one hosting a pressure transducer (Kulite®, XCQ-093, 1.7 bar A, max error: 0.05% FSO).

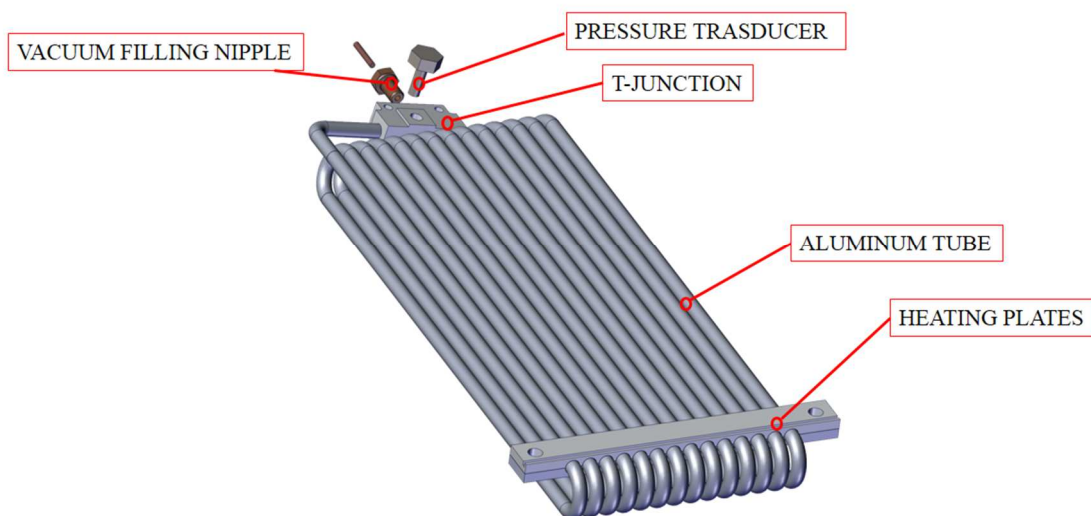

Figure 3: PHP Assembly Components.

The PHP is first evacuated by a two-stage turbo pump (Agilent® DS102, TwissTorr 84S), then is partially filled with a working fluid, FC-72, with a volumetric ratio of  $0.5 \pm 0.025$  and sealed. The design of the test-cell follows the criteria already chosen for PHOS Project, nevertheless the configuration has been upgraded with respect to the previous PHOS Project [6,7,8] in order to fulfil the space constraints required by the International Space Station Thermal Platform and allow a better recirculation of the fluid.

### 2.1.1 Evaporator Section

The PHP evaporator section consists of a series of two ceramic heaters (plates) connected in parallel. In PHOS experiment the heating element was realized by means of a heating cable wrapped around the tube, but the thermal contact was not optimized. The new heaters, custom made by INNOVACERA® on our design, are placed on a flat aluminium surface brazed on the PHP. The nominal resistance is  $18 \Omega$  at  $25^\circ\text{C}$ . The heating elements are powered up to 200W (corresponding to a radial wall to fluid local heat flux of  $12.6 \text{ W/cm}^2$ ) by 8 battery cells (SAFT® MP176065). The ceramic plates are in contact with the aluminium tube by means of an aluminium slab (heating plates in figure 3) glued on it. For safety reasons, the maximum temperature is fixed at  $150^\circ\text{C}$ , controlled by an electro-thermal switch.

### 2.1.2 Condenser Section

In order to be independent from the cooling section thermal inertia, a stable temperature should be maintained in the condenser section. Heat dissipation at constant temperature can be obtained using a phase change material in close contact with the condenser section. The material chosen is Octadecane paraffin wax. Its characteristics are shown in table 1. The paraffin wax should absorb heat via latent heat of fusion, and keep the condenser at constant temperature. However, as the thermal conductivity of the paraffin wax is small, after a certain amount of time, the melting front stops. Hence, the liquid paraffin surrounding the tubes is heated up (sensible heating), leading to an increase of the condenser temperature. This phenomenon is even more evident in milligravity condition due to the absence of convection. In order to avoid this effect, that was evident during the PHOS experiment, the paraffin thermal conductivity is enhanced by embedding it inside a metallic foam. Furthermore, since the metallic foam is highly porous, the overall mass of the PCM/ metallic foam assessment does not increase too much.

Table 1: Paraffin Wax Characteristics

|                      |   |
|----------------------|---|
| Density              | 814 (solid), 774 (liquid) [ $\text{kg/m}^3$ ] |
| Specific Heat        | 2160 [ $\text{J/kg.K}$ ]                      |
| Melting Point        | 28.0 [ $^\circ\text{C}$ ]                     |
| Boiling Point        | 317.9 [ $^\circ\text{C}$ ]                    |
| Heat of Fusion       | 244 [ $\text{kJ/kg}$ ]                        |
| Thermal Conductivity | 0.15 [ $\text{W/mK}$ ]                        |

Several studies in literature calculate an overall thermal conductivity ten times higher than the paraffin [9, 10], by using copper foams. Metallic foams are characterized by two parameters: porosity (the ratio between the foam weight and the weight of the same solid volume composed of the same material) and pore density (the number of pores in a linear inch PPI). From literature [11] it seems that the foam pore density influences the convective heat transfer, so it should not be important in a milli

gravity environment, while the porosity affects the melting process: higher values of the foam density mean higher thermal conductivity and, consequently, lower temperature variations at the condenser. For this reason, the best solution seems to be a relatively high density foam (88% porosity). Further tests are planned in the near future in order to correctly characterize the behavior of the embedded paraffin with the foam.

### 2.1.3 Temperature Measurements by optic fibers

The measurement is made by an SBI (Sensor Bragg Interrogator), consisting in an optical fiber which is doped in several locations obtaining small embedded sensors. A laser light is injected in the fiber and different wavelength spectra are reflected by the sensors depending on the sensor temperature. The SBI is indeed equipped with receptors able to measure the reflected wavelengths and thus to calculate the temperatures for all the sensor locations. The chosen configuration consists in 2 fibres each one with 12 sensors on them. Temperatures can be acquired with up to 1 KHz sampling frequency, with an accuracy of  $\pm 1$  °C, in a range between 0 and +150°C. It is worth noting the great advantages resulting from this configuration in terms of weight, reduced complexity of cabling and measure accuracy. The position of the FBG sensors on the PHP is schematically shown in Figure 4. Sensors position is symmetrical on both the PHP sides.

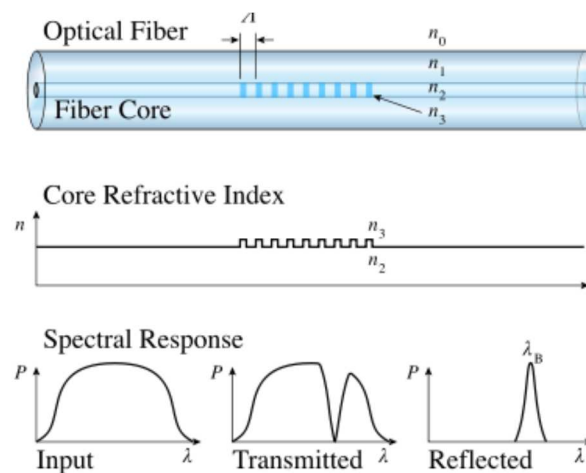

Figure 4: Optical fiber basic working principles.

As shown in figure 5, the experiment will be turned on fifteen minutes before launch. The main operation that will be conducted during the pre-launch phase is a preliminary heating of the PHP, done in order to keep the PCM (Phase Change Material) at a temperature close to its melting point. This operation is fundamental, since PHOS Project [6,7,8] highlighted that the paraffin temperature was too low at the beginning of the experiment to perform its function. Moreover, the ambient temperature at launch is strongly varying and frequently very low since the launch will take place at Kiruna, Sweden, on March, with typical environment temperatures varying from -30°C to 10°C. At lift-off the experiment supplies a different power from the one supplied in the pre-heating phase. It supplies 200W to the PHP, instead the pre-heating power is about 40W. The experiment will also start acquiring and saving (and sending to ground) temperature data, pressure and supplied power. Taken  $t = 0s$  as the lift-off time, after almost 65s a rocket despin (yo-yo) system will be activated, in order to obtain milli-g conditions. The apogee will be reached at almost  $t150s$ . At  $t+180s$  the experiment will be turned off and the on-board electronics will continue sending data on ground for redundancy.

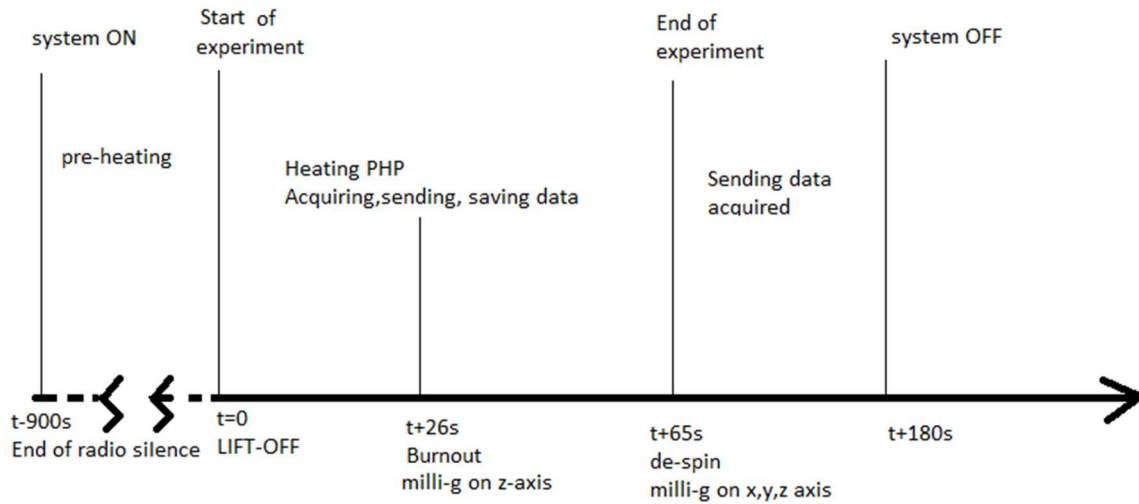

Figure 5: Experiment Timeline.

### 2.2 Electronic system

The objective of the electronic system is to provide the heating power necessary for the experiment, to acquire data and to communicate with the ground station. These functions are onto 4 independent sub-modules: an Actuation Module, an Interface Module, a Main Control Unit (MCU) and a Power Distribution Unit (PDU) shown in figure 6.

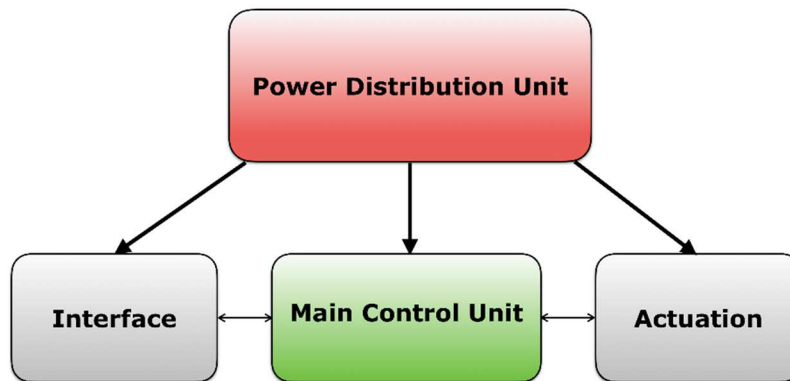

Figure 6: Electronic System Overview

The actuation module controls a heating system during the experiment, to provide the necessary heating power to it. It does it in two different phases: the pre-heating phase, where the system has to maintain the PCM temperature close to its melting point, and the heating phase, where a constant power shall be delivered to the PHP. This functionality has been implemented combining a Digital Controller and a PWM (Pulse Width Modulation) Driver, together with a Sensing Module to acquire the delivered power. The PWM signal passes through a gate driver and connects heaters to the power supply, controlling the power delivered with the duty cycle of the PWM Signal. Note that the delivered power is low pass filtered by the thermal pole of the heater, resulting in a mediated output thermal power. The interface module has the role to host a secondary sensor acquisition, which will not be used for the system control. The module will acquire internal pressure values of the PHP and three axis acceleration values. The communication will be established with the REXUS Service Module and, through it, with the ground station. The link is created through opto-isolators and the communication protocol is RS-422. The Main Control Unit (MCU) is a commercial board from Embedded ARM (TS7200®): it is a programmable board hosting a LINUX® distribution with on board memory and interface features such as ADC channels and RS-485 port. The board will be responsible for the timeline and the control of the



experiment. Moreover, the board interacts with the data acquisition board responsible for temperatures acquisition (SBI). The Power distribution module hosts several DC-DC converters in order to guarantee the appropriate voltage to all the electronic components. One of the DC-DC converters (DCM24AP480T320A50 VICor<sup>®</sup>) provides the heating power to the heating module.

### 3 Expected results

With the results coming from the REXUS campaign it will be possible to analyse and to understand the thermal-fluid dynamics of the device response at varying acceleration, in time. Temperature and pressure inside the PHP are expected to show a different oscillating behaviour after the occurrence of milli-gravity. From a scientific point of view this experiment could provide fundamental data in order to improve the prediction capability of numerical models in milli-g environment and help to understand the physical phenomena that characterize the start-up at low-g conditions. Moreover, it could be possible to analyse the performance of PCM with a metallic foam and improve the numerical modelling of this complex phenomenon.

#### 3.1 Ground tests

In order to compare U-PHOS results with the PHOS results on ground, the experiment is going to be tested both in vertical and horizontal position. In vertical position, the device operates as a two-phase thermosyphon. The liquid phase accumulates close to the evaporator section and boils continuously. The generated vapor rises towards the condenser section and, sometimes, drags up fluid batches (liquid and vapor) in the so-called "bubble lift" mode.

In horizontal position, due to the fluid stratification: the liquid phase resides in the lower tube region and the vapour phase on the higher one. Still, in the new configuration, a small gravity head will be present, and the device will work once again as a loop thermosiphon. Since the gravity head is smaller than the vertical case, the performance is expected to be lower too.

#### 3.2 Flight test

The flight test that will be performed during REXUS 22 launch aims to confirm the predicted behaviour of the PHP obtained during the parabolic flights. As previously asserted, a PHP has been tested in milli-g environment during the 61<sup>st</sup> ESA Parabolic Flight Campaign [5]. Each parabolic manoeuvre is divided in 3 parts: 20 s at 1.8g (hyper-gravity) followed by 22 s at 0.01g (milli-gravity) and 20-25 s at 1.8g (hyper-gravity). Figure 7 shows the temporal evolution of the pressure inside the PHP during one parabolic sequence.

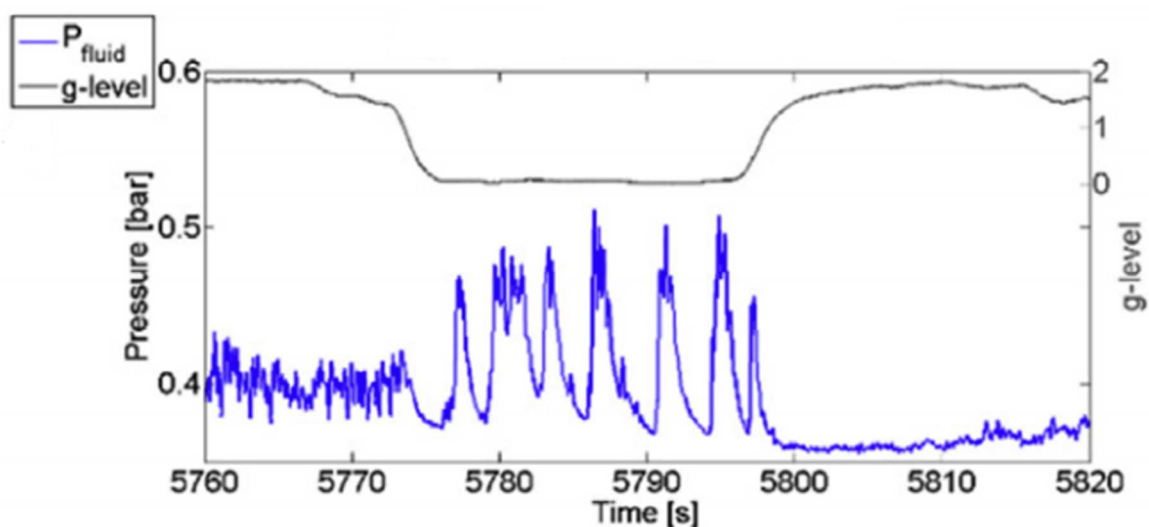

Figure 7: Fluid Pressure inside PHP and Gravity Field [5].

As illustrated in figure 7, during milli-gravity condition pressure fluctuation inside the PHP is recorded. This fluctuation is due to fluid motion inside the tube, mainly due to the slug and plug flow pattern, as the gravity vector components are almost zero during the milli-g condition.

No significant data was obtained from the PHOS experiment because of a malfunction of the de-spin system. We expect that the U-PHOS zero gravity results will be similar to the one in figure 7: hopefully the pressure fluctuations will be present during the whole micro-gravity period (90s) which is longer than the one achievable in parabolic flights.

### 3.3 *Data analysis plan*

Data will be post-processed and analyzed in order to detect evaporator and condenser external wall temperature evolutions, fluid pressure variation frequency and amplitude, fluid temperature variation frequency and amplitude. All data recorded will be plotted against time and in particular:

- Tube wall temperature in the evaporator and condenser zone will be plotted together with the acceleration and heat power input.
- Local fluid pressure in the condenser section will be plotted together with the acceleration and power heat input, in order to estimate the time response to low-g environment of the system.
- FFT analysis on the pressure signal will be carried out in order to verify if different thermal/hydraulic behaviours are characterised by a dominant frequency.
- Melting front of the paraffin will be detected over time acquiring temperatures by means of the FBG sensors. Experimental data will be compared with the ones previously obtained on ground and the ones coming from the numerical model of the PCM melting phenomenon.

From the acquired data it will be possible to evaluate the equivalent thermal resistance and the thermal performances of the device in milli-g environment.

## 4 **Conclusions**

The objectives and test cell of U-PHOS Project have been explained in details, with reference to its thermal, mechanical and electronic design. U-PHOS Project aims to characterize the behaviour of a large diameter Pulsating Heat Pipe (PHP), a promising device for thermal management in space application.

The experiment is going to be tested in milli-gravity condition, on board REXUS 22 sounding rocket. The test-cell of the experiment consists of an annealed aluminium tube, of internal diameter of 3 mm, bended in 14 turns and closed end-to-end in a loop. The test-cell is equipped with ceramic heaters as heating source, and paraffin wax embedded with metal foam as cooling section. Temperature and pressure data are collected during the whole experiment both on ground and flight condition. In particular temperature data are detected using fibre bragg grating sensors inserted inside an optic fibre and in contact with the external wall of the PHP.

The experiment is an upgrade of a previous experiment (PHOS) that was launched on board REXUS 18 sounding rocket. Enhancement of the heat sink thermal conductivity and a better accuracy, reliability and integrability of the temperature sensors, are the main innovations with respect to PHOS. Important results will be obtained for the characterization of the device in low-gravity environment. At the present time the experiment is under critical design review. The launch is scheduled for March 2017.

## **Acknowledgements**

The present work has been carried out as part of the REXUS BEXUS program, supported by European space agency (ESA), German Aerospace Research Establishment (DLR) and Swedish National Space Board (SNSB). The ESA MAP INWIP project for funding the project, the International Scientific Team on Pulsating Heat Pipes, the school of engineering and AAVID Thermalloy, especially Marco La Foresta and Lorenzo Caporale, for the crucial help in the test cell manufacturing. We also would like to thank Alessandro Signorini and INFIBRA Technology for the great help. The authors would like to thank the PHOS team for the support and encouragement to continue their work.



## References

- [1] Akachi H 1990 *US Patent* 4.921.041 Structure of a heat pipe.
- [2] Akachi H 1993 *US Patent* 5.219.020 Structure of a micro heat pipe
- [3] Gu J, Kawaji M and Futamata R 2004 Effects of gravity on the performance of pulsating heat pipes *J. Thermophys. Heat Transfer* **18** 371-378.
- [4] Mameli M, Araneo L, Filippeschi S, Marelli L, Testa R and Marengo M 2014 Thermal response of a closed loop pulsating heat pipe under a varying gravity force *Int. J. Therm. Sci.* **80** 11-22.
- [5] Mangini D, Mameli M, Georgoulas A, Araneo L, Filippeschi S and Marengo M 2015 A pulsating heat pipe for space applications: ground and microgravity experiments *Int. J. Therm. Sci.* **95** 53-63.
- [6] Creatini F, Guidi GM, Belfi F, Cicero G, Fioriti D, Di Prizio D, Piacquadio S, Becatti G, Orlandini G, Frigerio A, Fontanesi S, Nannipieri P, Rognini M, Morganti N, Filippeschi S, Di Marco P, Fanucci L, Baronti F, Manzoni M, Mameli M, Marengo M, 2015 Pulsating Heat Pipe Only for Space: Results of the REXUS 18 Sounding Rocket Campaign *XXXIII UIT Congress L'Aquila, Italy, Journal of Physics: Conference Series* 655 (2015) 012042 doi:10.1088/1742-6596/655/1/012042.
- [7] Creatini F, Guidi GM, Belfi F, Cicero G, Fioriti D, Di Prizio D, Piacquadio S, Becatti G, Orlandini G, Frigerio A, Fontanesi S, Nannipieri P, Rognini M, Morganti N, Filippeschi S, Di Marco P, Fanucci L, Baronti F, Manzoni M, Mameli M, Marengo M, 2015 Thermal Response of a Pulsating Heat Pipe on Board the Rexus 18 Sounding Rocket: PHOS Experiment Chronicles *UK Heat Transfer Conference, Edinburgh UK.*
- [8] Creatini F, Guidi GM, Belfi F, Cicero G, Fioriti D, Di Prizio D, Piacquadio S, Becatti G, Orlandini G, Frigerio A, Fontanesi S, Nannipieri P, Rognini M, Morganti N, Filippeschi S, Di Marco P, Fanucci L, Baronti F, Manzoni M, Mameli M, Marengo M, 2015 Phos Experiment: Thermal Response of A Large Diameter Pulsating Heat Pipe On Board Rexus 18 Rocket 2015 *22nd ESA PAC Symposium Tromso, Norway.*
- [9] Xiao X, Zhang P, Li M 2013 Preparation and thermal characterization of paraffin/metal foam composite phase change material *Applied Energy* **112** 1357-1366.
- [10] Xiao X, Zhang P, Li M 2014 Effective thermal conductivity of open-cell metal foams impregnated with pure paraffin for latent heat storage *Int. J. of Thermal Sciences* **81** 94-105.
- [11] Lafdi K, Mesalhy O, Shaikh S 2007 Experimental study on the influence of foam porosity and pore size on the melting of phase change materials *J. of Applied Physics* **102** 083549.